

THERAPY PHOTO ARE APPLICATION OF ALL OF OUR THERAPY DEVICE

Bronchitis ----- (Respiratory Diseases)

Cause of Disease:

The irritation of the bronchial tubes, caused by flu, or smoke, dirt, pollution, etc, which can lead to emphysema and pulmonary heart disease, etc.

Treatment Mechanism of infrared therapy device / Bio-spectrum Treatment Device:

Improve the blood circulation of the inflammatory tissue; repair and regeneration of damaged tissue; strengthen immunity and anti-infection; regulate the vegetative nervous system; reduce the symptoms of cough

Treatment Method:

Irradiated area: Affected area and Acupoint area 6 and 9,

Irradiated times and duration: 2 times daily; 30 min. each time

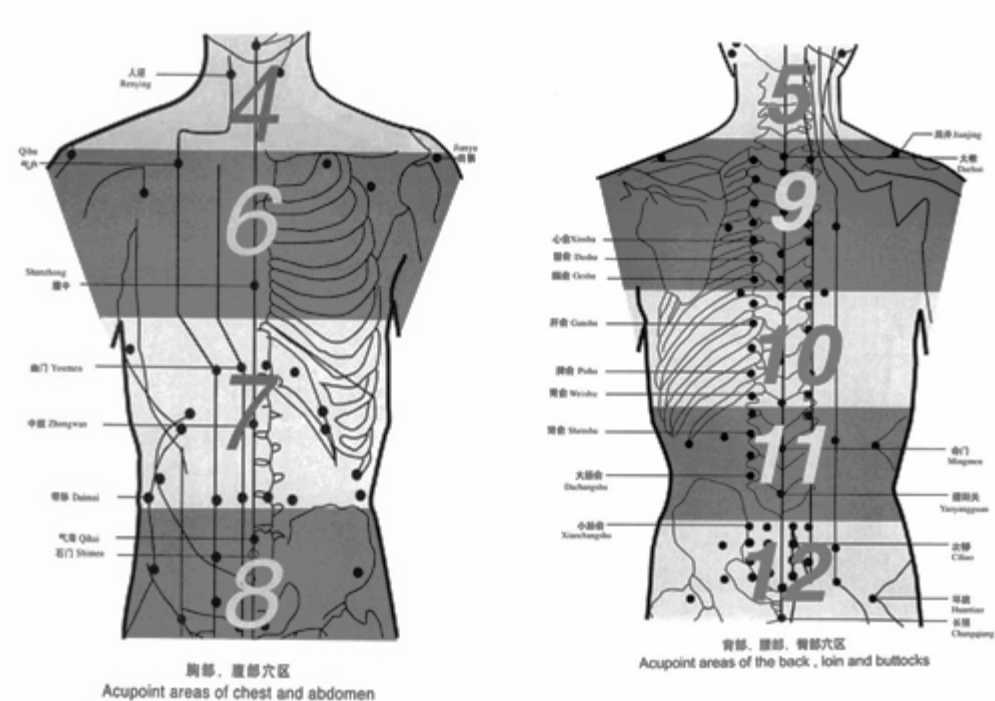

PNEUMONIA----- (RESPIRATORY DISEASES)

Cause of Disease:

Pneumonia is an inflammation of the lung, usually caused by an infection. Three common causes are bacteria, viruses and fungi.

Treatment Mechanism of infrared therapy device / Bio-spectrum Treatment Device:

Promote absorption of inflammatory exudation; improve the blood circulation of inflammatory lesions; strengthening the immune system and anti-infection Treatment

Method:

Irradiated area: Affected part and Acupoint area 6 and 9;

Irradiated times and duration: 2 times daily; 30 min each time + medicine

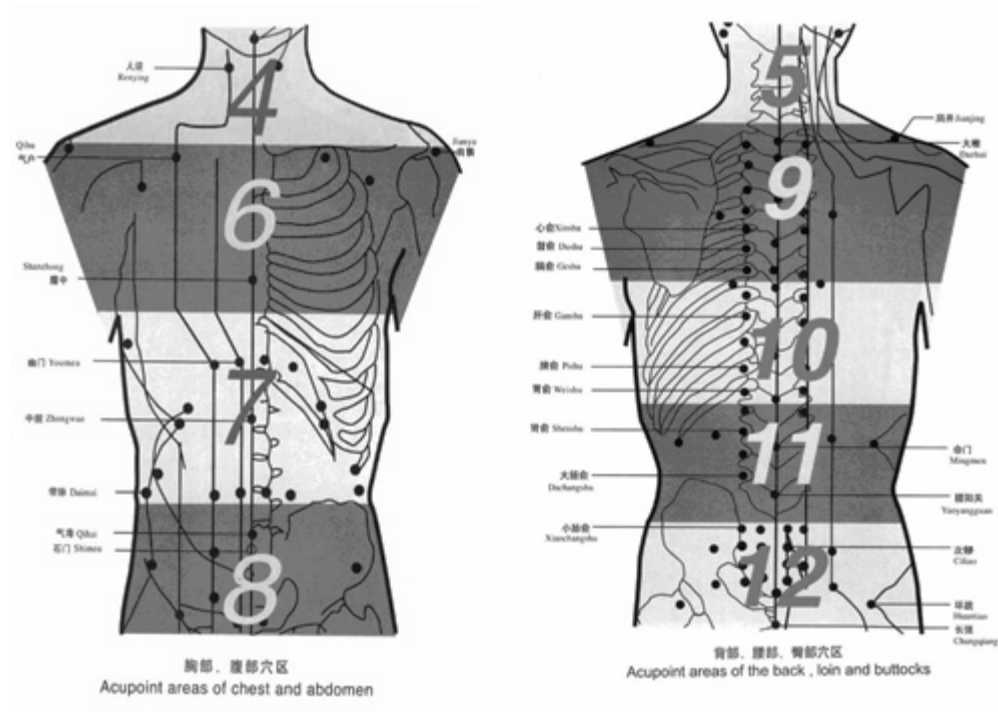

BRONCHIAL ASTHMA----- (RESPIRATORY DISEASES)

Cause of Disease:

Bronchial asthma is a chronic inflammatory disease of the airways that causes periodic "attacks" of coughing, wheezing, shortness of breath, and chest tightness. Bronchial asthma triggers may include: Allergens (such as food, pollen, mold, dust mites, and pet dander) , stimulus(smoke, cold air, toxins) and emotional stress and anxiety.

Treatment Mechanism of infrared therapy device / Bio-spectrum Treatment Device:

Relieving asthma: enhance the body non-specific immune mechanisms and the role of desensitization; regulate and balance the autonomic function; reduce the activity of sympathetic nerve.

Prevention: It occurs mostly in Autumn and Winter. Early prevention is a good way. Treatment Method:

Irradiated area: Acupoint area 4 and 6, Irradiated times and duration: 2-3 times daily, 40 min each time

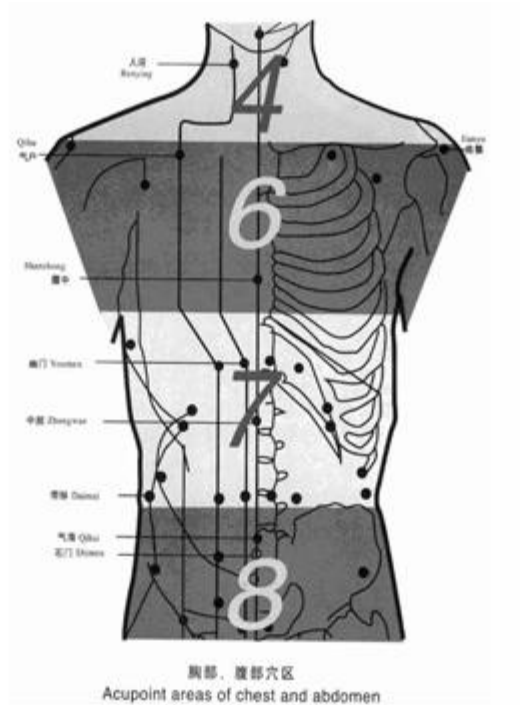

COLD----- (RESPIRATORY DISEASES)

Cause of Disease:

Cold is a viral infectious disease of the upper respiratory system which affects primarily the nose. Symptoms include a cough, sore throat, runny nose, and fever. Causes include virus and poor immunity.

Treatment Mechanism of infrared therapy device / Bio-spectrum Treatment Device:

Prevention: Irradiate the Acupoint of Yongquan 28 on the sole of the foot

Treatment Method:

Irradiate of the nasopharynx (if any inflammation), head (if headache), Dazhui Acupoint 9 (the protrusion on the back of neck)

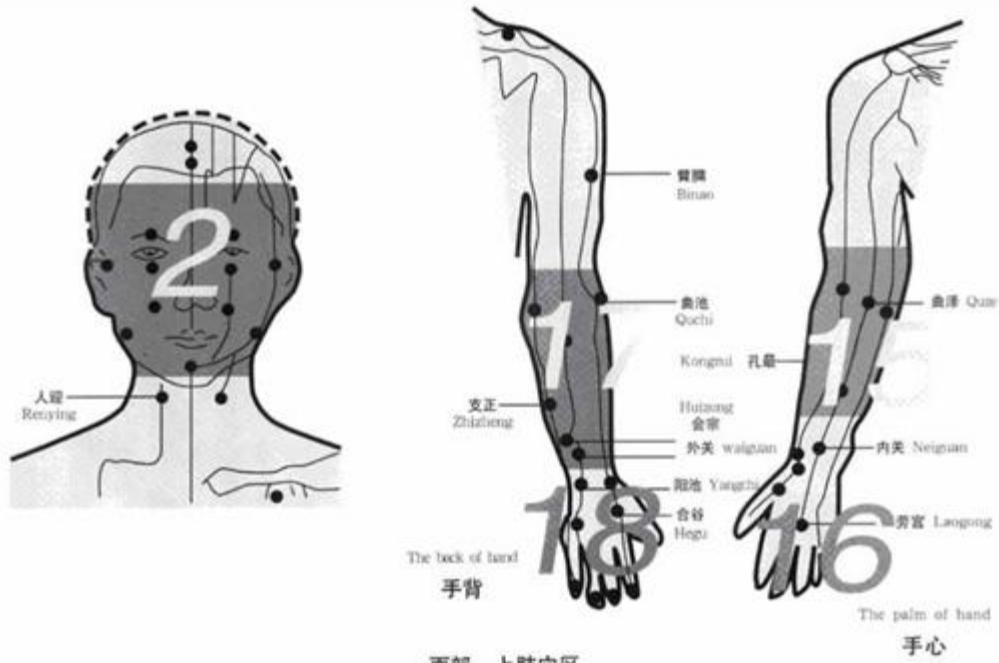

面部、上肢穴区
Acupoint areas of upper face and limbs

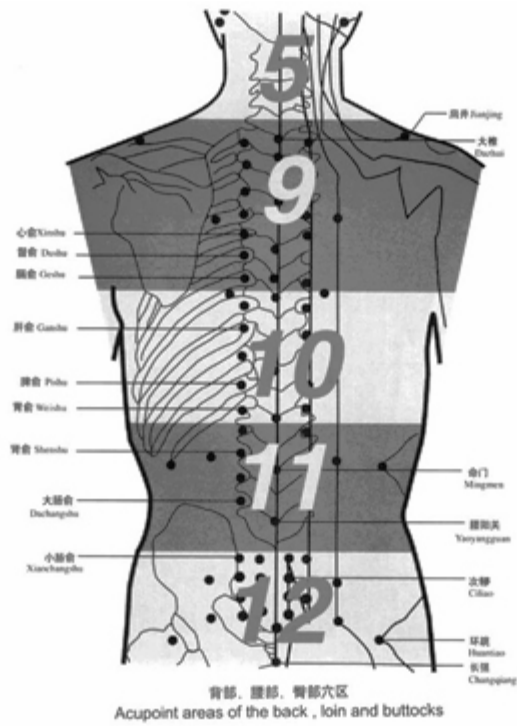

背部、腰部、臀部穴区
Acupoint areas of the back, loin and buttocks

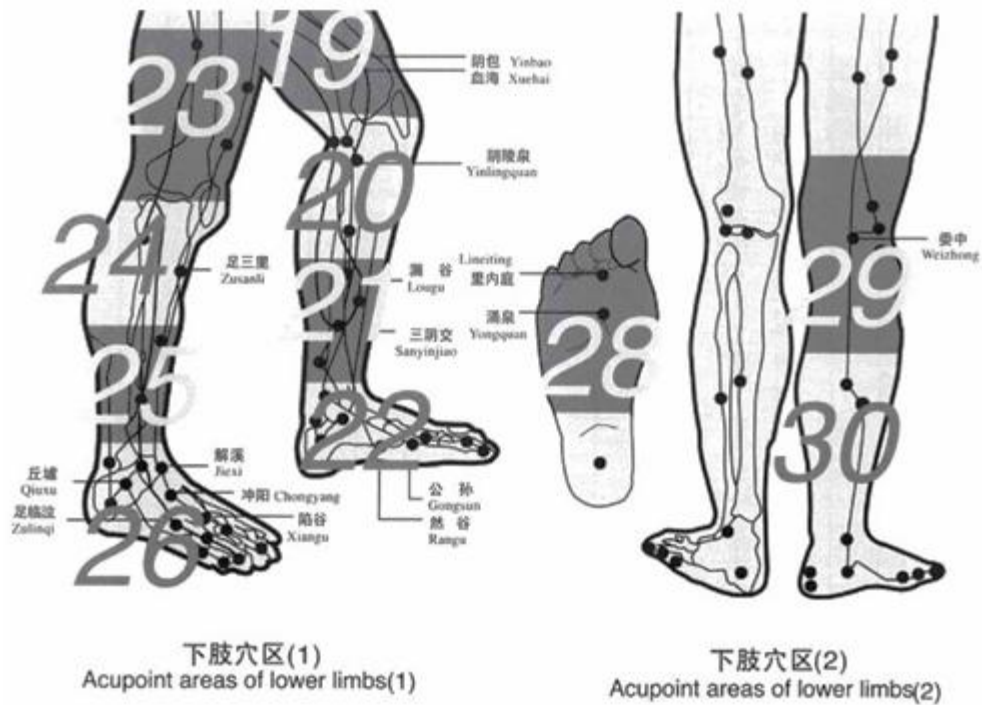

PULMONARY EMPHYSEMA, PNEUMOTHORAX, PLEURISY

Respiratory Diseases

Cause of Disease:

pulmonary emphysema:

It is a long-term, progressive disease of the lungs that primarily causes shortness of breath. It is often caused by long-term exposure to air pollution or smoking.

pneumothorax:

Pneumothorax is an abnormal collection of air or gas in the pleural space that separates the lung from the chest wall, and that may interfere with normal breathing.

pleurisy:

Pleurisy or pleuritis is an inflammation of the tissues, pleura, surrounding the lungs and lining the rib cage. It is marked by severe chest pain, which can be especially pronounced if someone is breathing hard from exertion.

Treatment Mechanism of infrared therapy device / Bio-spectrum Treatment Device:

improve the pulmonary blood circulation; promote tissue repair; eliminate the local inflammation

Treatment Method:

Irradiated area: chest and back, Irradiated times and duration: 1~2 times daily, 30 min each time

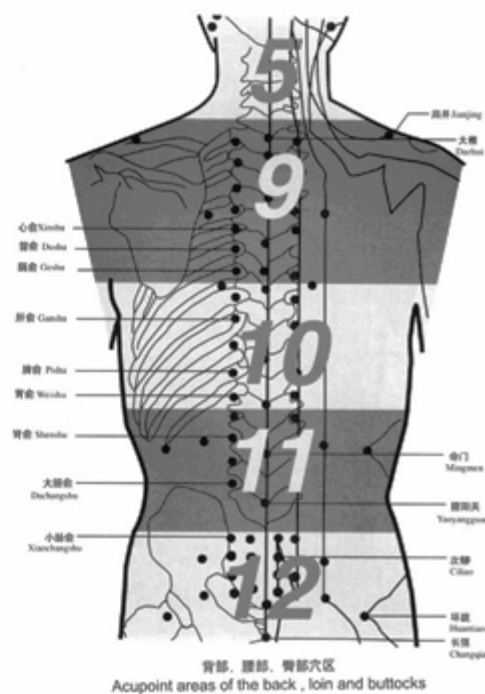
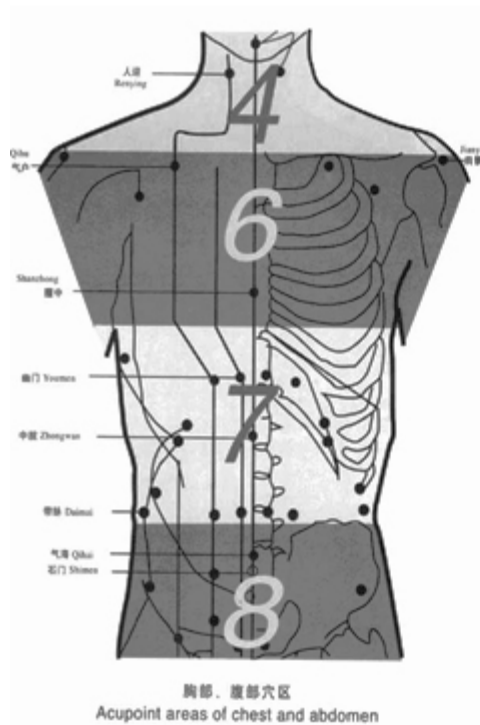

GASTRITIS, GASTRIC ULCER, DUODENUM ULCER, CHRONIC HEPATITIS

Digestive Diseases

Cause of Disease:

Gastritis: Gastritis is an inflammation of the lining of the stomach. (bad eating habits+poor immunity)

Peptic ulcer (Gastric ulcer, Duodenum ulcer): A peptic ulcer is a sore in the lining of your stomach or your duodenum. It happens when the acids that help you digest food damage the walls of the stomach or duodenum. The most common cause is infection with a bacterium called *Helicobacter pylori*. Another cause is the long-term use of nonsteroidal anti-inflammatory medicines (NSAIDs) such as aspirin and ibuprofen.

Treatment Mechanism of infrared therapy device /Bio-spectrum Treatment Device:

improve the local microcirculation; speed up the metabolism; promote granulation tissue regeneration and repair of the granulation tissue; enhance of gastric and intestinal peristalsis to promote gastric emptying and protect mucous membrane; accelerate ulcer healing and the absorption of inflammatory exudation; regulate the body balance function, adjust the balance of gastric acid and pepsin;

Hepatitis: Hepatitis is an inflammation of the liver, most commonly caused by a viral infection.

Treatment Mechanism of infrared therapy device / Bio-spectrum Treatment Device:

Spectrum go through the skin and acupressure pathways to the liver, which makes liver temperature rise and increase liver blood flow to improve the nutritional status of liver cells. When plasma albumin is

significantly increased. Plasma colloid osmotic pressure is promoted and portal vein pressure is reduced, it will gradually eliminate hepatic microcirculation and metabolic disorders, speed up the repair and regeneration of liver cells, accelerate the retraction of the swollen liver and spleen and reduction of jaundice, and promote the recovery of inflammation and liver function.

Treatment Method:

Irradiated area: Acupoint area 7, 10 and 24, Irradiated times and duration: 1~2 times daily, 40 min each time

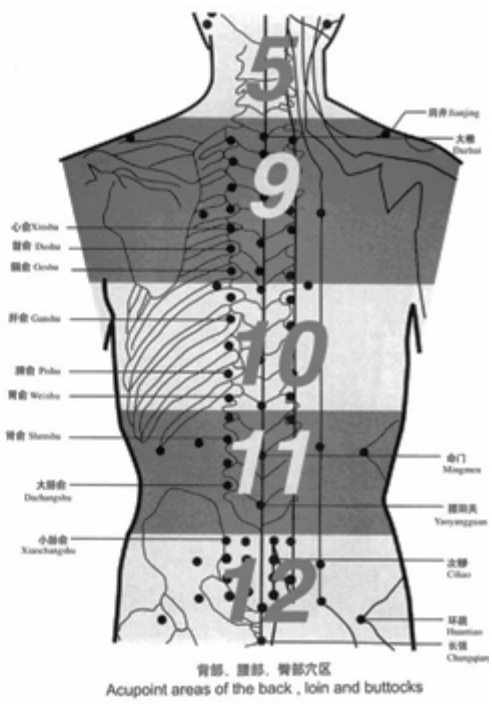
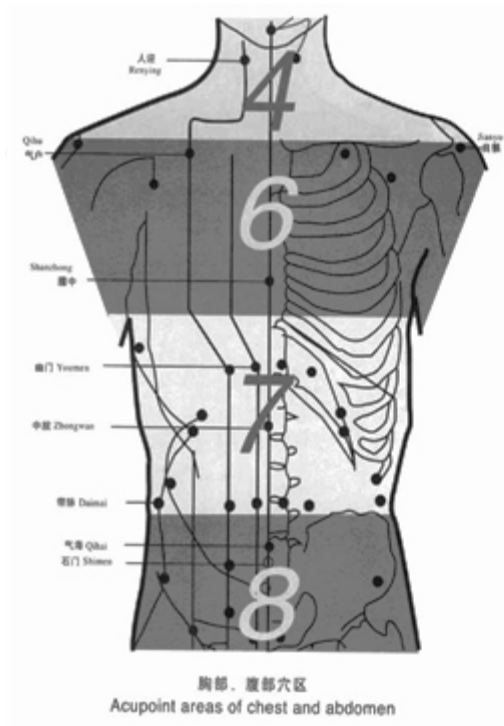

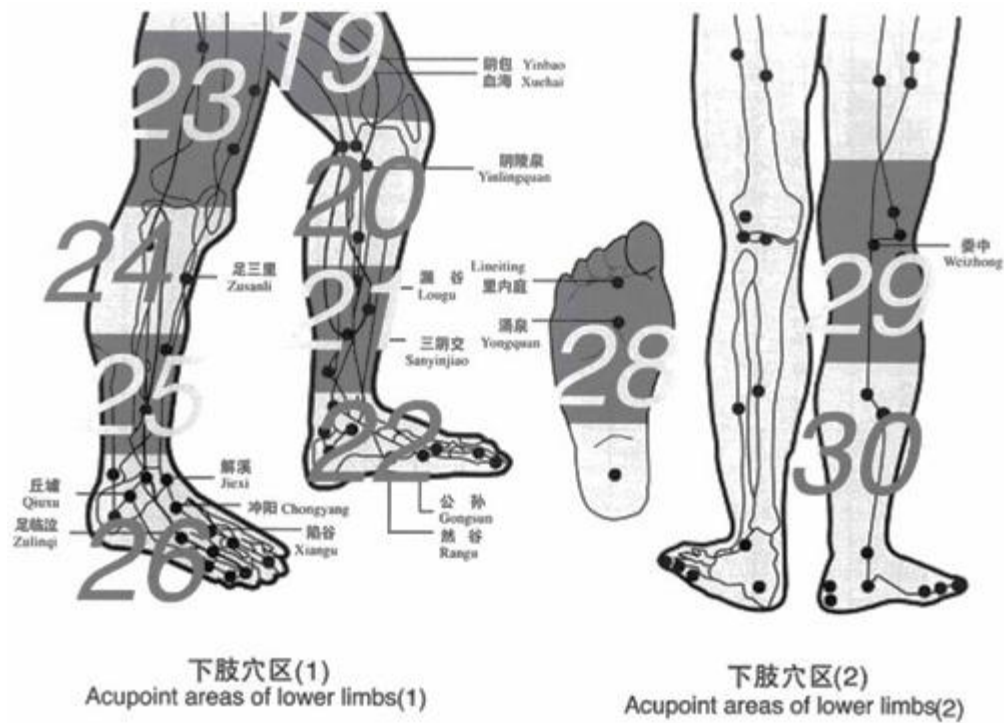

ENTERITIS----- (DIGESTIVE DISEASES)

Cause of Disease:

Enteritis is usually caused by eating or drinking substances that are contaminated with bacteria or viruses.

Treatment Method:

Irradiated area: Acupoint area 8 and 11, Irradiated times and duration: 2~3 times daily, 40 min each time

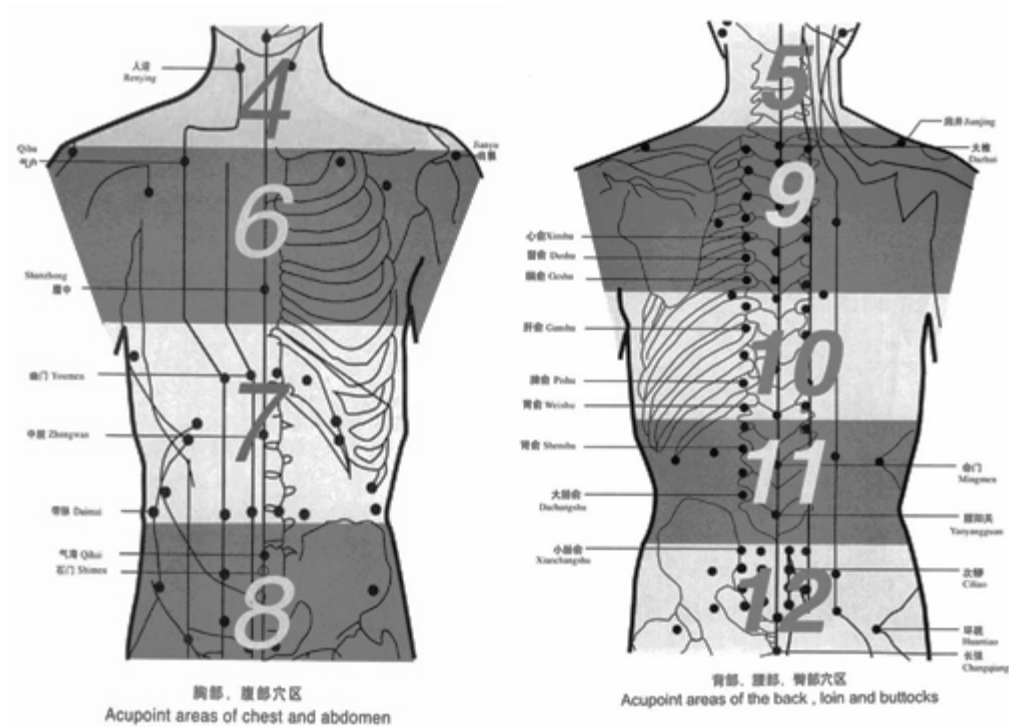

CONSTIPATION, DIARRHEA —— (DIGESTIVE DISEASES)

Cause of Disease:

Constipation: Constipation is usually caused by a disorder of bowel function rather than a structural problem. Common causes of constipation include: Hypothyroidism, some medicines, Stress and Depression, intestinal obstruction, etc.

Diarrhea: Diarrhea may be caused by infection by bacteria (the cause of most types of food poisoning) or malabsorption (where the body is unable to adequately absorb certain nutrients from the diet), etc

Treatment Mechanism of infrared therapy device / Bio-spectrum Treatment Device:

regulate gastrointestinal function, and enhance human antimicrobial activity

Treatment Method:

Irradiated area: Acupoint area 8 and 28, Irradiated times and duration: 1~2 times daily, 25 ~ 30 min each time

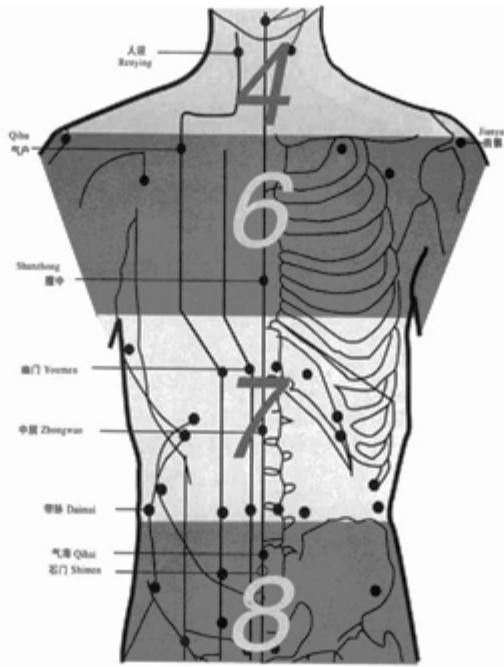

胸部、腹部穴区
Acupoint areas of chest and abdomen

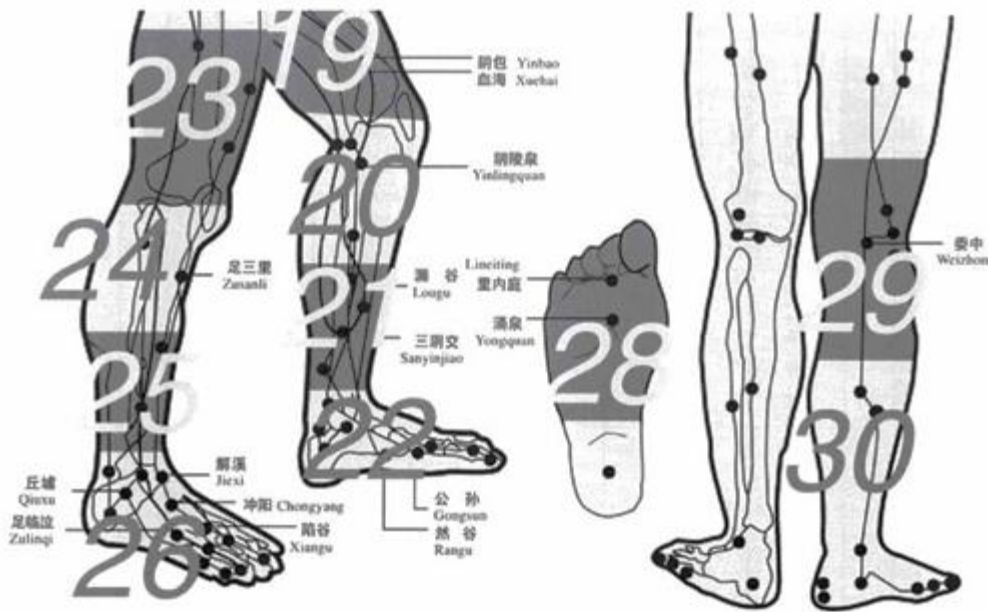

下肢穴区(1)
Acupoint areas of lower limbs(1)

下肢穴区(2)
Acupoint areas of lower limbs(2)

CHOLECYSTITIS, PANCREATITIS, PERITONITIS

Digestive Diseases

Treatment Method:

Irradiation affected area 2 times a day, 20 min each time + drugs

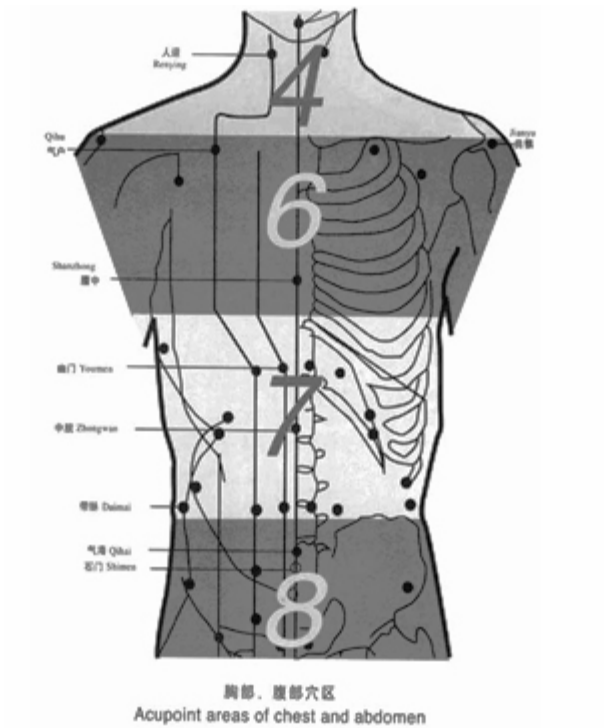

ACNE, DERMATITIS, PSORIASIS—— (DERMATOLOGY)

Cause of Disease:
endocrine disorders

Treatment Mechanism of infrared therapy device / Bio-spectrum Treatment Device:
Regulate endocrine

Treatment Method:

Keep the skin clean, avoid spicy foods.

Irradiated area: For men, affected area and Shenyu Acupoint 11 on the back waist.

For women, Affected area and Guilai Acupoint on the lower abdomen.

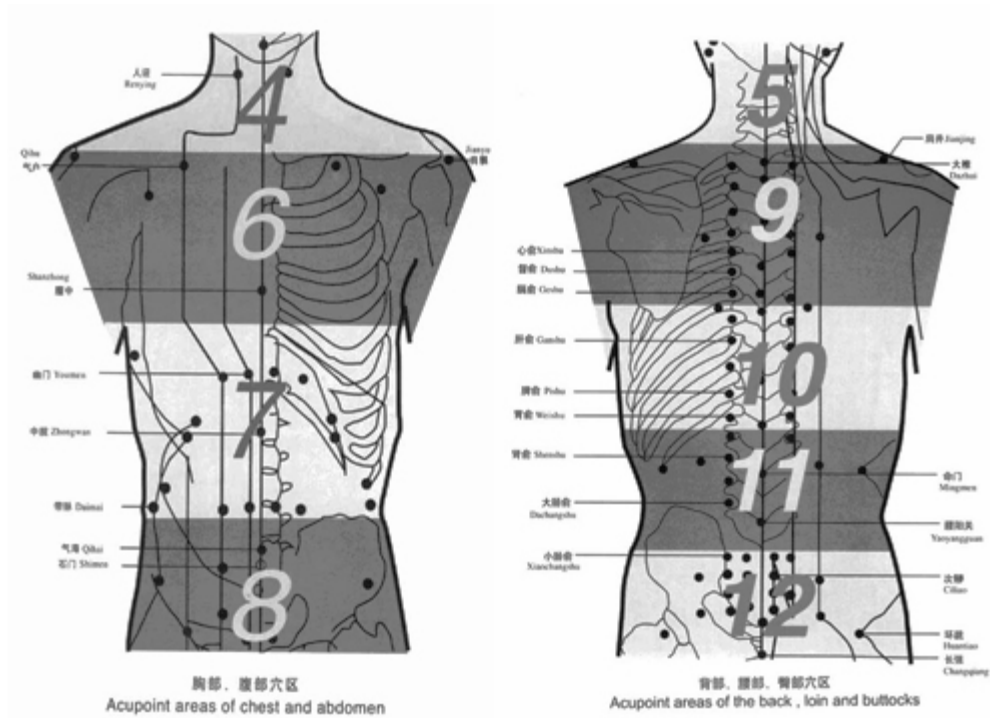

HERPES, ECZEMA----- (DERMATOLOGY)

Cause of Disease:

Herpes: Herpes is a viral disease causing eruptions of the skin or mucous membrane. Herpes simplex commonly affects the face and mouth region and in some cases the genitals. Herpes zoster (or shingles, zoster) erupts along a nerve path often accompanied by severe neuralgia.

Treatment Mechanism of infrared therapy device / Bio-spectrum Treatment Device:

Adjust and improve the body's immune status; promote humoral and cellular immune mechanisms; improve the body's own immune system; eliminate the virus and reduce the inflammation.

Treatment Method:

Irradiated area: affected area, Acupoint area 28; Irradiated times and duration: 1-2 times daily, 30 min. each time

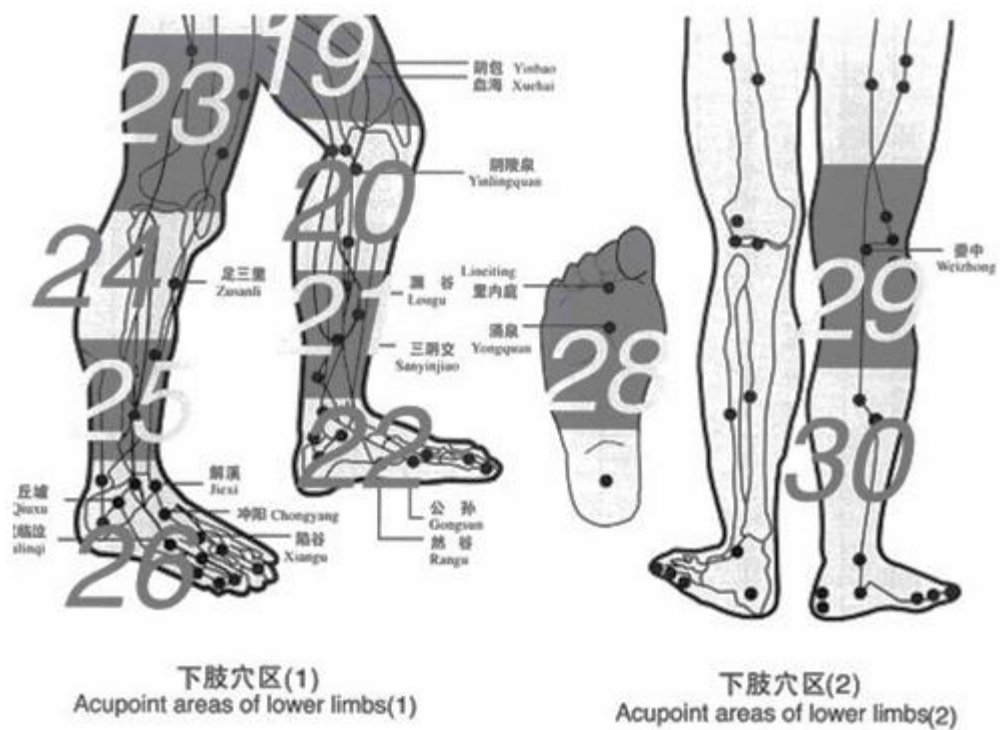

DERMATOLOGY

Frostbite, Mild burns, Bedsore, Hemorrhoids, Carbuncle, Furuncle, Chronic ulcer of lower limb, Traumatic ulcer, Wound healing

Treatment Method:

Irradiated area: affected area and Acupoint area 12

Irradiated times and duration: 1-2 times daily, 30-40 min. each time

Please note: keep the skin clean and use the low power

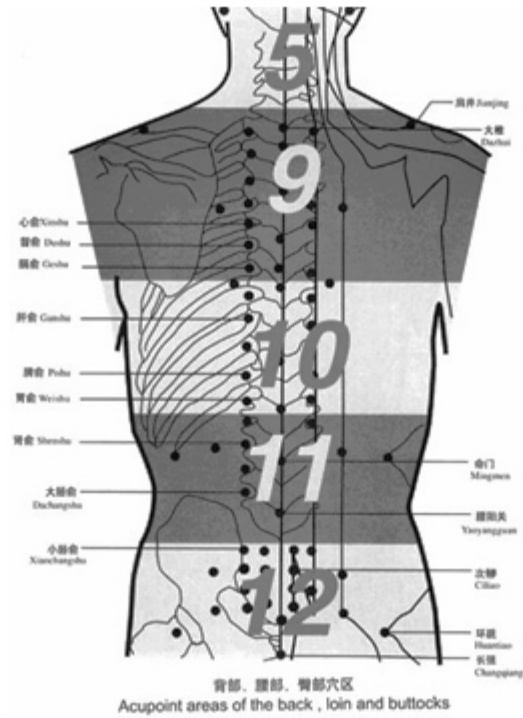

NEURODERMATITIS----- (DERMATOLOGY)

Treatment Method:

Irradiated area: affected area and Acupoint area 9

Irradiated times and duration: 1-2 times daily, 30 min. each time

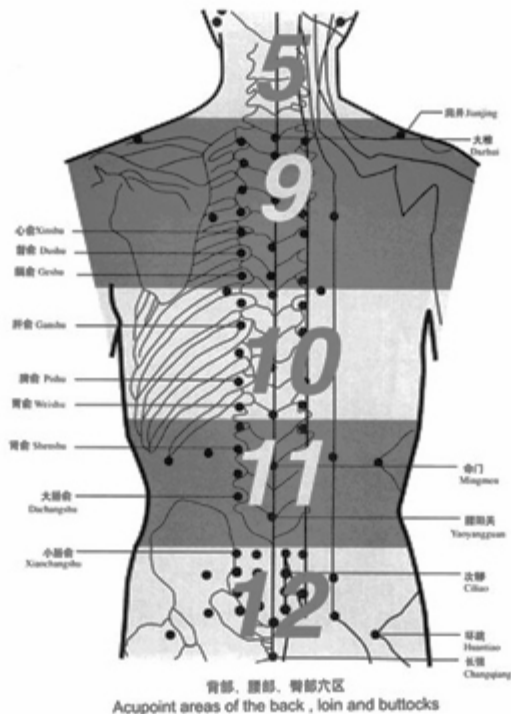

CORONARY HEART DISEASE

Cardiovascular Diseases

Cause of Disease:

Coronary heart disease is the narrowing or blockage of the coronary arteries, usually caused by atherosclerosis. Atherosclerosis (sometimes called “hardening” or “clogging” of the arteries) is the buildup of cholesterol and fatty deposits (called plaques) on the inner walls of the arteries. These plaques can restrict blood flow to the heart muscle by physically clogging the artery or by causing abnormal artery tone and function. Without an adequate blood supply, the heart becomes starved of oxygen and the vital nutrients. This can cause chest pain

called angina. If blood supply to a portion of the heart muscle is cut off entirely, or if the energy demands of the heart become much greater than its blood supply, a heart attack (injury to the heart muscle) may occur.

Treatment Mechanism of infrared therapy device / Bio-spectrum Treatment Device:

Improve blood circulation; increase fluidity and deformability of red blood cells, speed up electrophoretic mobility; reduce platelet aggregation and blood viscosity

Treatment Method:

Irradiated area: chest and back each for 20 minutes. For patients with pacemakers, irradiate Neiguan Acupoint on the wrist and Yongquan Acupoint 28 on the bottom of the foot instead of irradiation on chest and back.

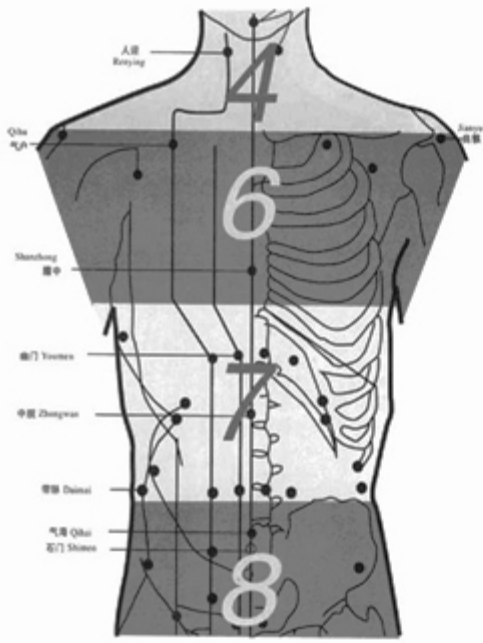

胸部、腹部穴区
Acupoint areas of chest and abdomen

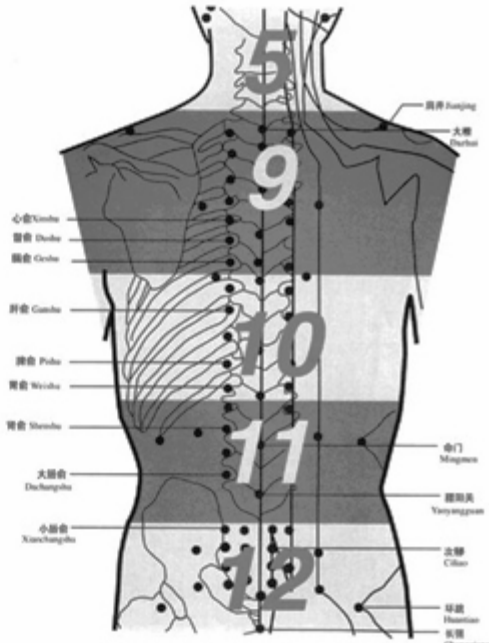

背部、腰部、臀部穴区
Acupoint areas of the back, loin and buttocks

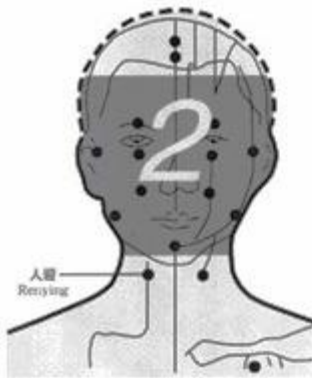

面部、上肢穴区
Acupoint areas of upper face and limbs



The back of hand
手背

The palm of hand
手心

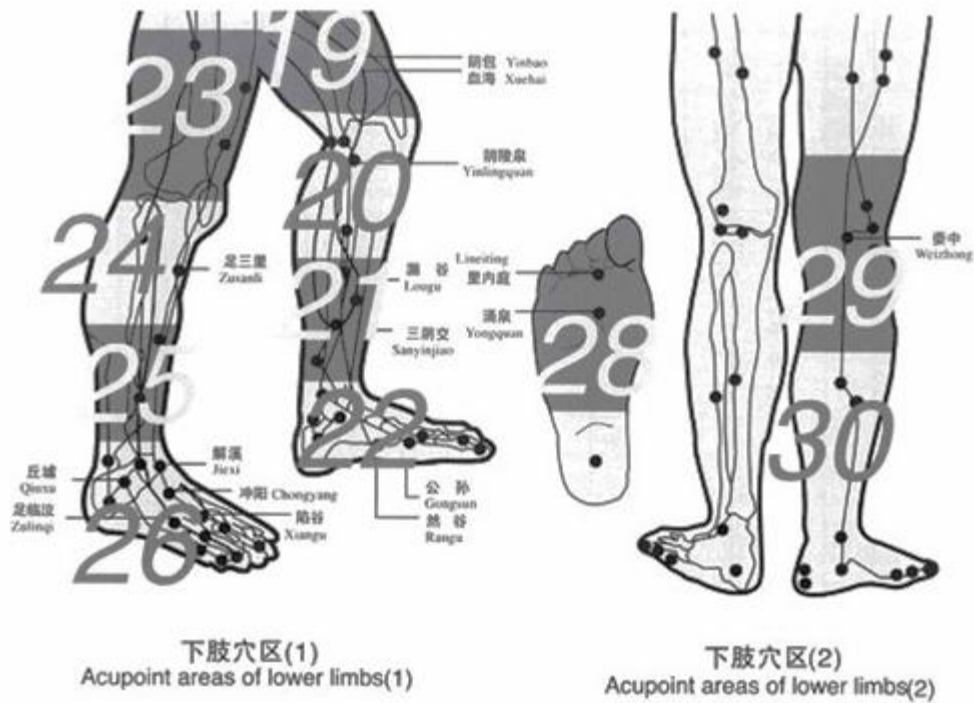

HIGH BLOOD PRESSURE

Cardiovascular Diseases

Cause of Disease:

Elements of controlling the blood pressure: the quantity of blood from the heart, quantity of blood in the blood vessels, blood viscosity, arterial elasticity, peripheral vascular resistance

Treatment Mechanism of infrared therapy device / Bio-spectrum Treatment Device: Lower blood viscosity; enhance blood vessel elasticity; bi-directionally regulate blood pressure;

Treatment Method:

Irradiated Area: Baihui Acupoint 1 on the head and Yongquan Acupoint 28 on the sole of the foot, 20 min. each time, 2 times daily.

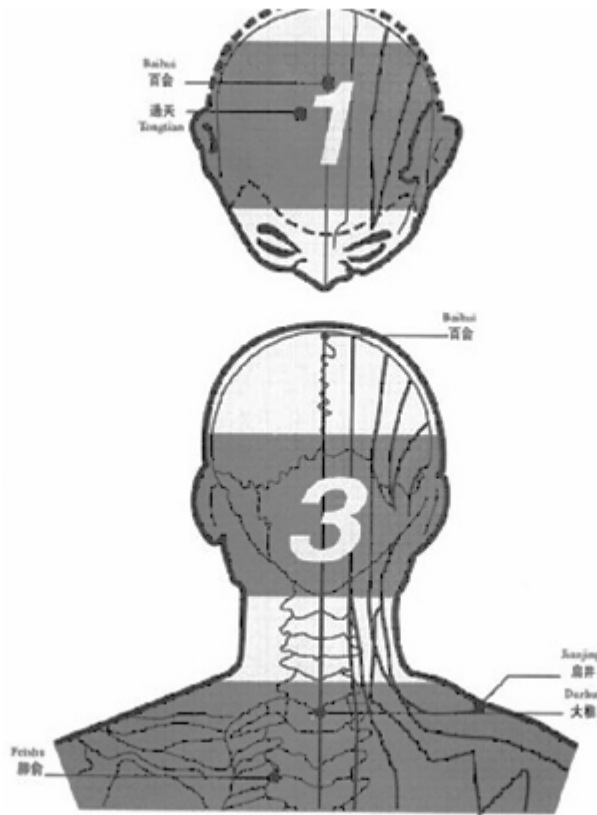

头部、肩部穴区
Acupoint areas of the head and shoulder

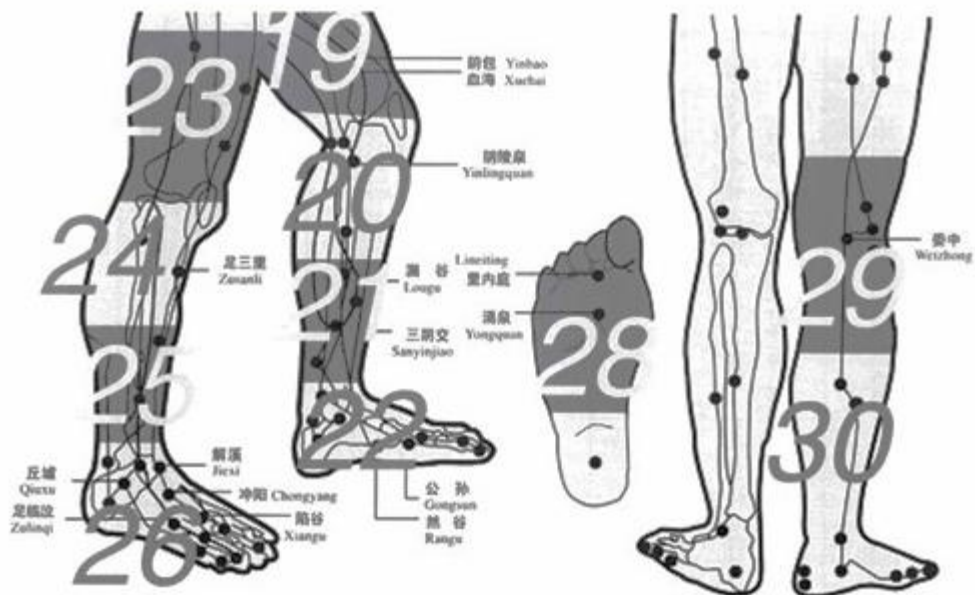

下肢穴区(1)
Acupoint areas of lower limbs(1)

下肢穴区(2)
Acupoint areas of lower limbs(2)

VARICOSE VEINS, PHLEBITIS-

Cardiovascular Diseases

Cause of Disease:

Varicose veins: Varicose veins or arteries are veins that have become enlarged and tortuous. Any vein may become varicose, but the veins most commonly affected are those in your legs and feet. Veins have leaflet valves to prevent blood from flowing backwards (retrograde flow). When veins become varicose, the leaflets of the valves no longer meet properly which allows blood to flow backwards and they enlarge even more.

Phlebitis: Phlebitis is an inflammation of a vein. Phlebitis can occur in both the surface (superficial) or deep veins. Superficial phlebitis affects veins on the skin surface. Deep vein thrombophlebitis affects the larger blood vessels deep in the legs. Thrombophlebitis is the term used when a blood clot in the vein causes the inflammation.

Treatment Mechanism of infrared therapy device / Bio-spectrum Treatment

Device: Improve blood circulation; repair damaged tissue

Treatment Method:

Irradiated Area: affected area 20 min. daily

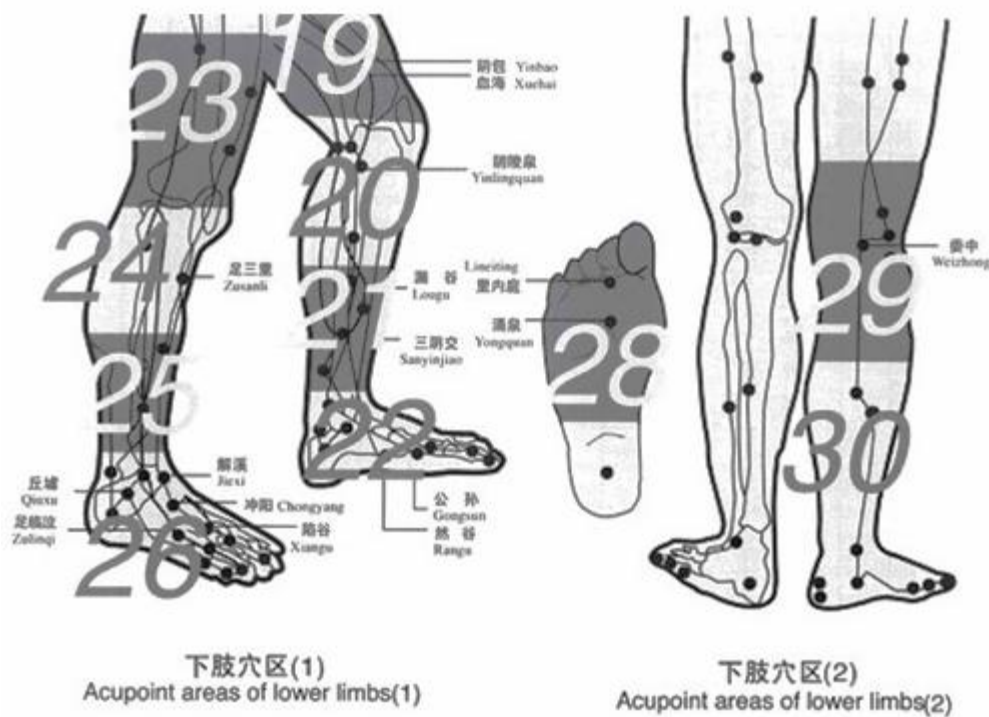

SCALP HEMATOMA, CEREBRAL HEMORRHAGE

Cerebral and Nervous System Diseases

Treatment Method:

Irradiated Area: affected area 20 min. each time, 2 times daily

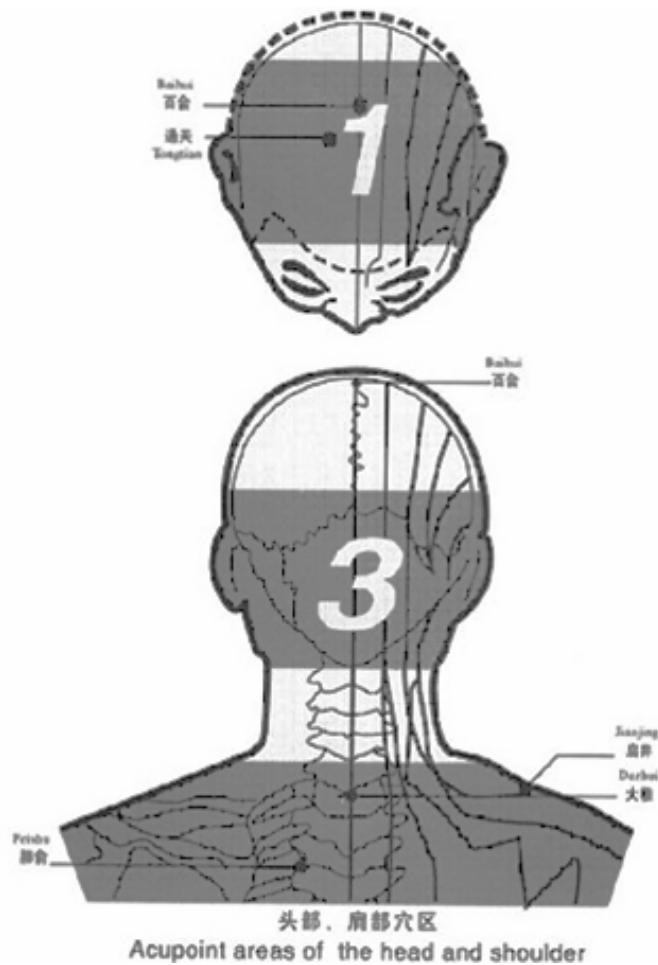

INSOMNIA

Cerebral and Nervous System Diseases

Treatment Mechanism:

Regulate the nervous system; improve blood supply to the brain; help with sleep

Irradiated Area: Baihui Acupoint 1 on the head and Yongquan Acupoint 28 on the sole of the foot, 30 min. each time, 2 times daily.

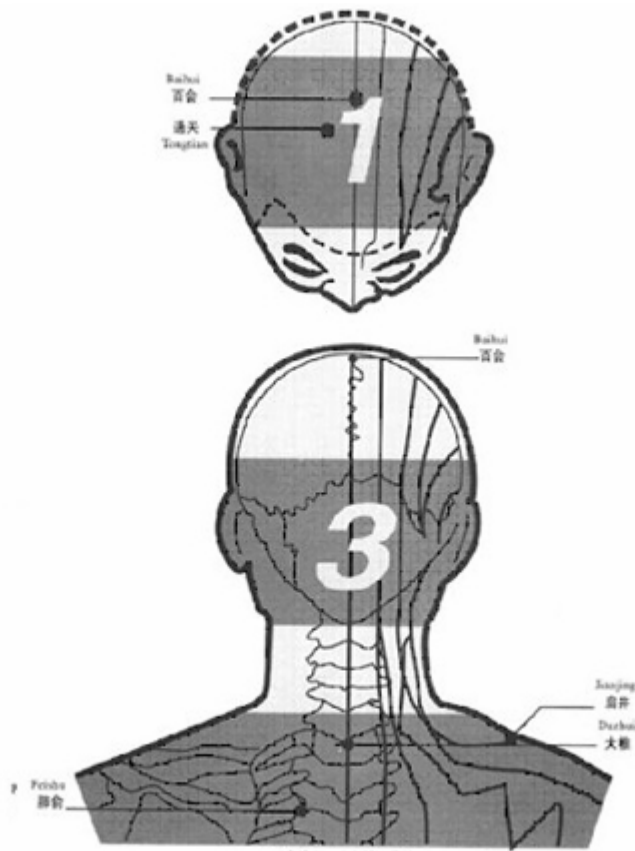

头部、肩部穴区
Acupoint areas of the head and shoulder

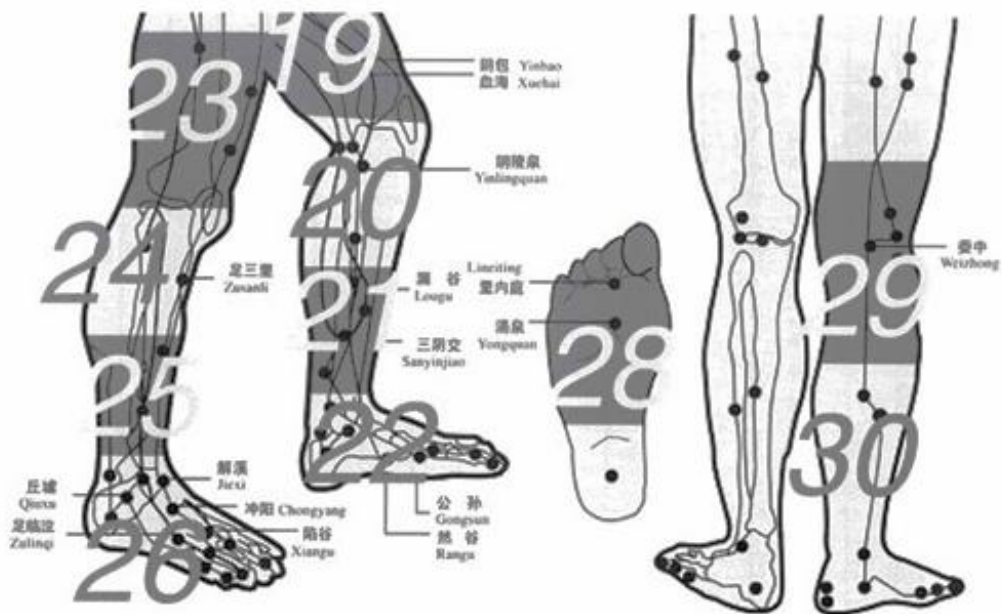

下肢穴区(1)
Acupoint areas of lower limbs(1)

下肢穴区(2)
Acupoint areas of lower limbs(2)

DIABETES

Endocrine System Diseases

Cause of Disease:

Diabetes is a condition in which the body either does not produce enough, or does not properly respond to, insulin, a hormone produced in the pancreas. In diabetes, the body either fails to properly respond to its own insulin, does not make enough insulin, or both. This

causes glucose to accumulate in the blood, often leading to various complications.

Treatment Mechanism of infrared therapy device / Bio-spectrum Treatment Device:

Stimulate the release of insulin, reduce edema of the pancreatic islet

Treatment Method:

Irradiated Area: the left upper abdomen (ie, the surface projection area of pancreas) and Sanyinjiao Acupoint located on the inside of the ankle, Piyu Acupoint Located below the crest of thoracic vertebra XI, Weiyu Acupoint near the 12th thoracic vertebra (T12) + Acupuncture 2 times daily, 30 min. each time

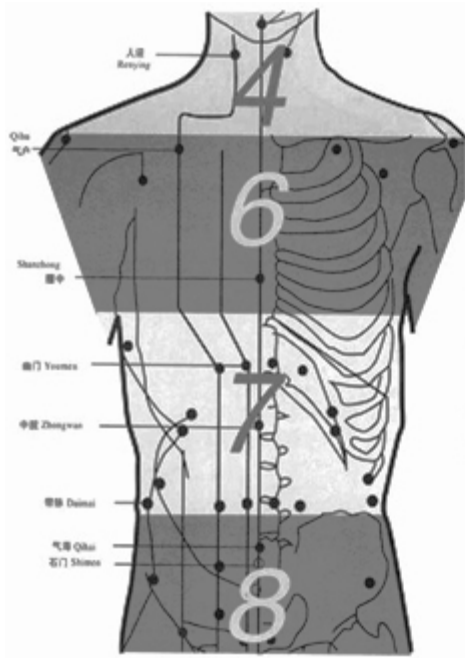

胸部、腹部穴区
Acupoint areas of chest and abdomen

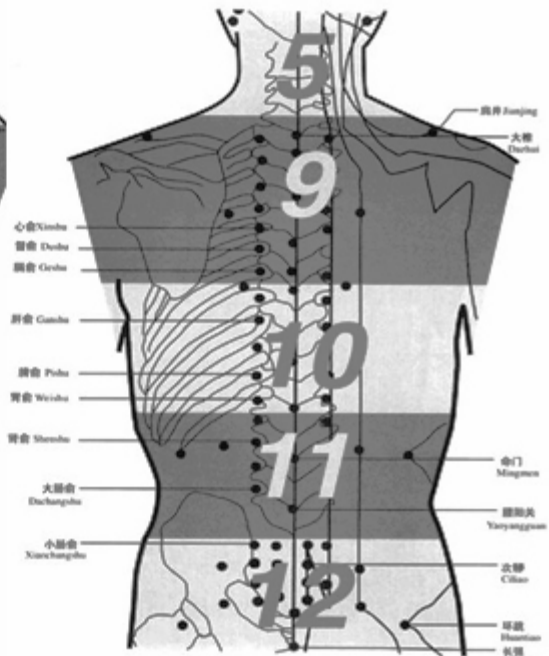

背部、腰部、臀部穴区
Acupoint areas of the back, loin and buttocks

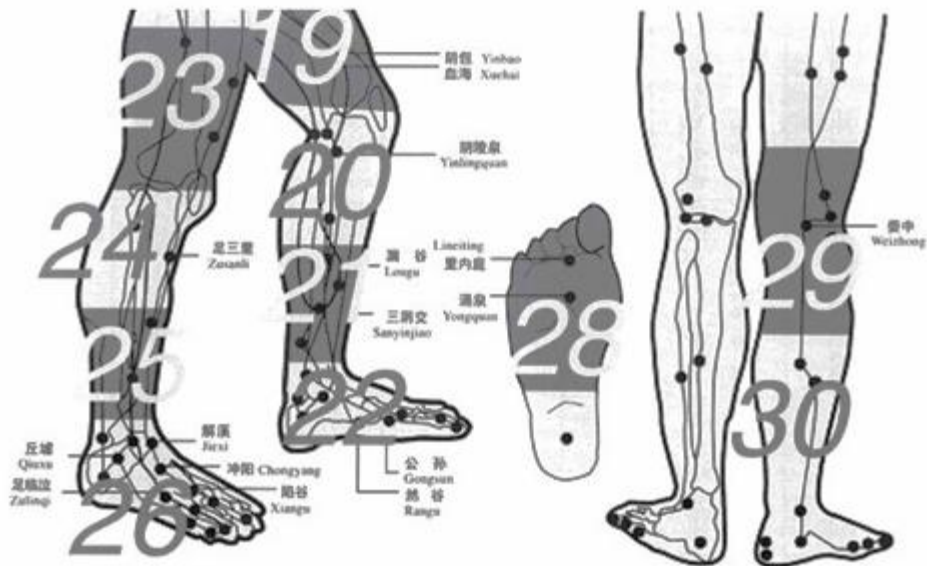

下肢穴区(1)
Acupoint areas of lower limbs(1)

下肢穴区(2)
Acupoint areas of lower limbs(2)

CANKER ULCER, GINGIVITIS, PERIODONTITIS

E.N.T. Department and Stomatology Department

Treatment Method:

Irradiated area: Affected area and Acupoint area 18

Irradiated times and duration: twice daily and 30 min. each time

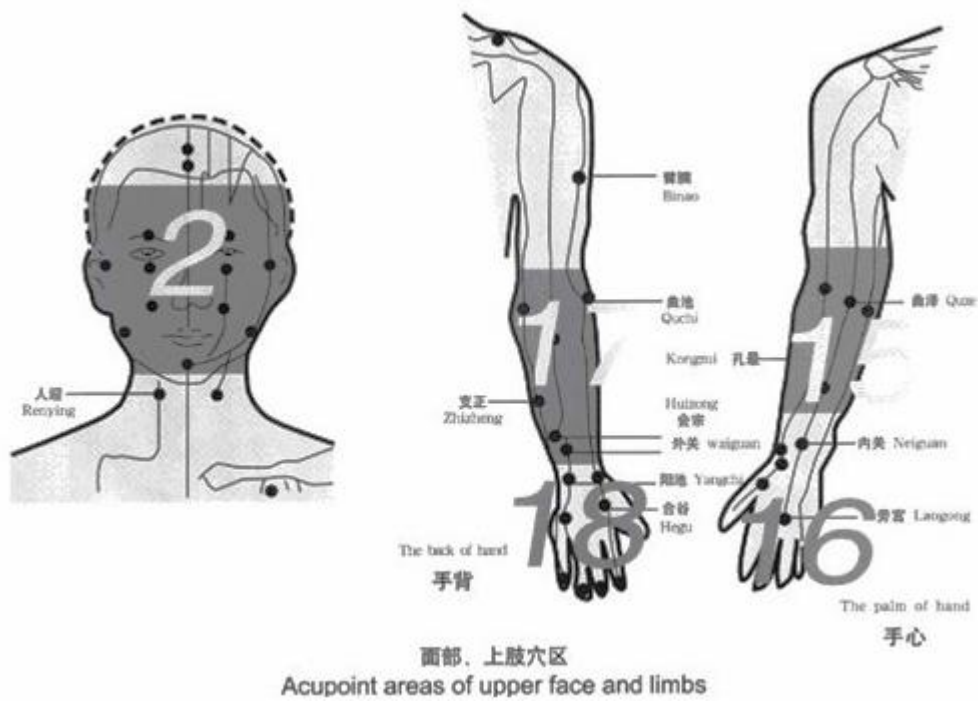

HEADACHE, TRIGEMINAL NEURALGIA, SCIATICA

Cerebral and Nervous System Diseases

Irradiation with infrared therapy device + Acupuncture

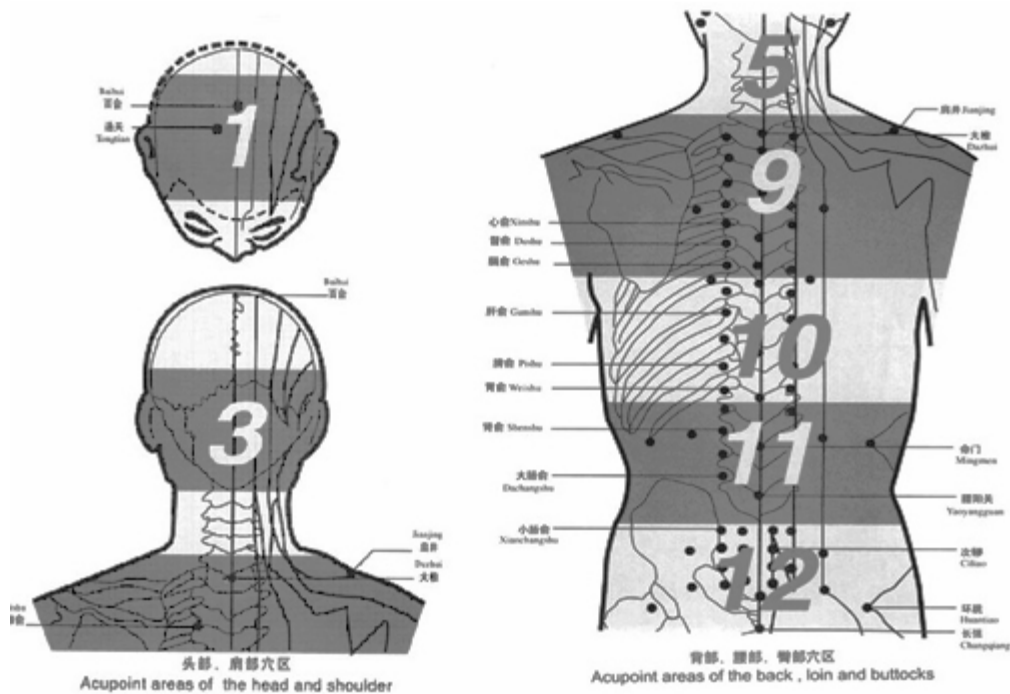

OTITIS MEDIA, TINNITUS, EAR INFECTIOUS DISEASES

E.N.T. Department and Stomatology Department

Treatment Method:

Irradiate the ear and use antibiotics. If the Otitis Media caused by stress and fatigue, irradiate the ear and back waist, also lower abdomen and Yongquan Acupoint 28 on the sole of foot .

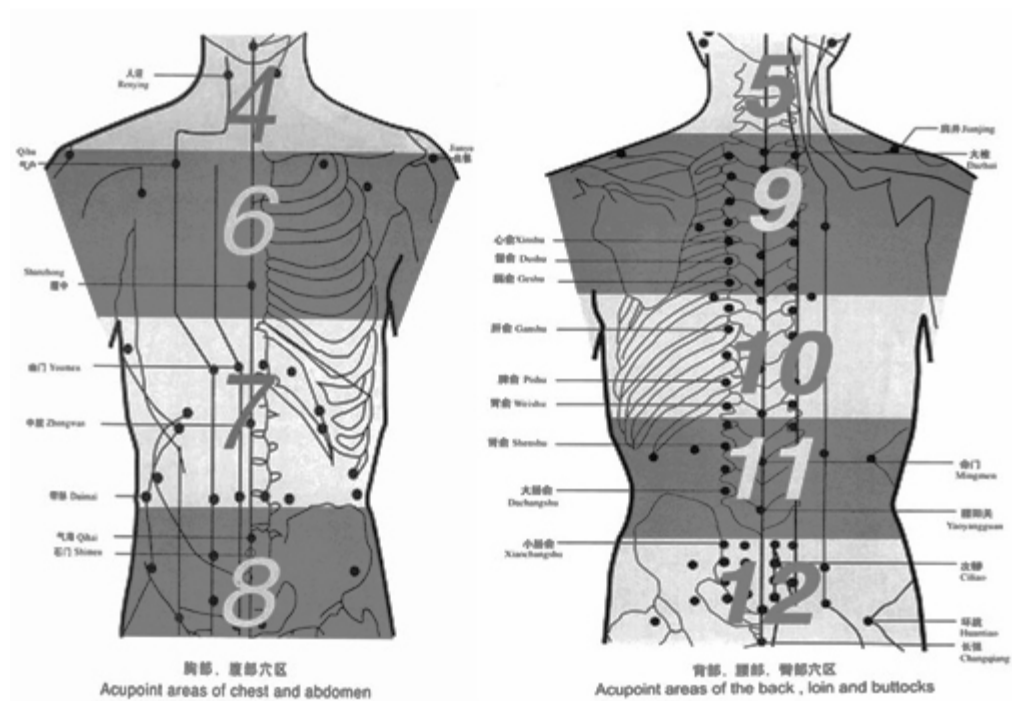

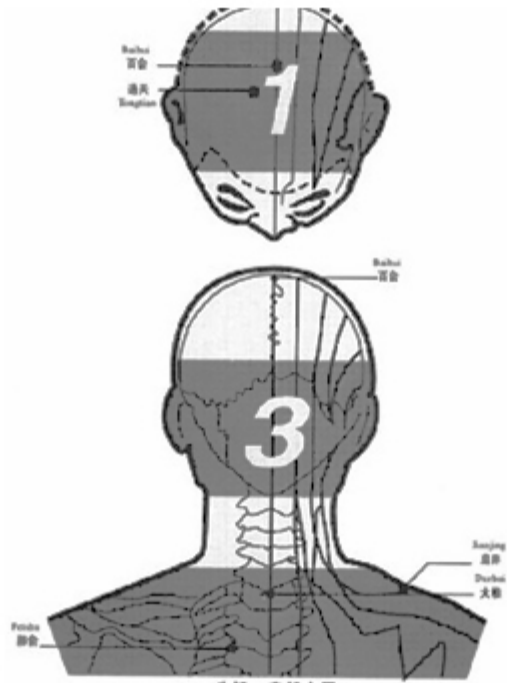

头部、肩部穴区
Acupoint areas of the head and shoulder

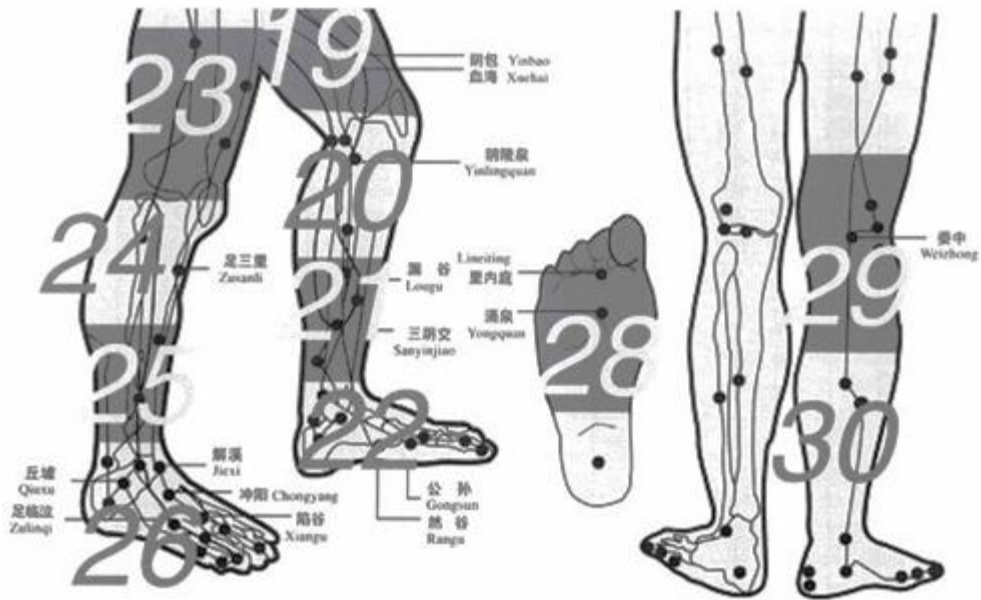

下肢穴区(1)
Acupoint areas of lower limbs(1)

下肢穴区(2)
Acupoint areas of lower limbs(2)

FACIAL PARALYSIS, MYASTHENIA GRAVIS

Cerebral and Nervous System Diseases

Irradiation with infrared therapy device + Acupuncture

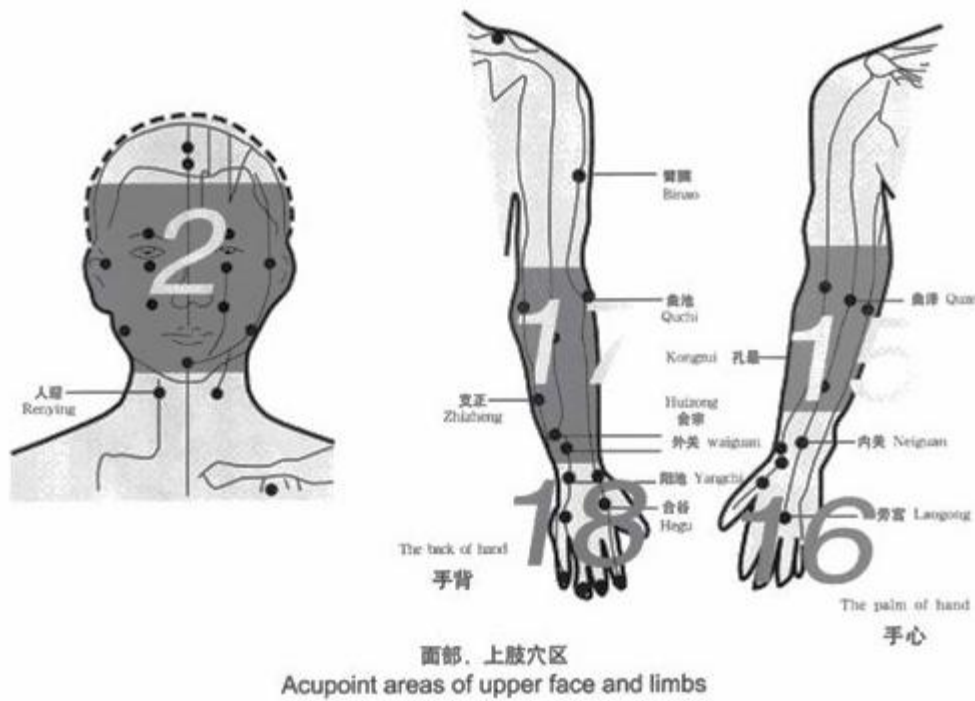

CLIMACTERIC SYNDROME

Endocrine System Diseases

Cause of Disease:

Climacteric syndrome refers to a series of symptoms caused by disorders of the endocrine system and vegetative nervous system due to hypofunction of ovary in climacteric women.

Treatment Mechanism of infrared therapy device / Bio-spectrum Treatment Device:

Regulate endocrine; promote hormonal balance and sex hormone secretion; regulate autonomic dysfunction

Treatment Method:

Irradiated Area: For women, lower abdomen and Yongquan Acupoint 28 on the sole of the foot; for men, Shenyu Acupoint on the back waist and Yongquan Acupoint 28 on the sole of the foot;

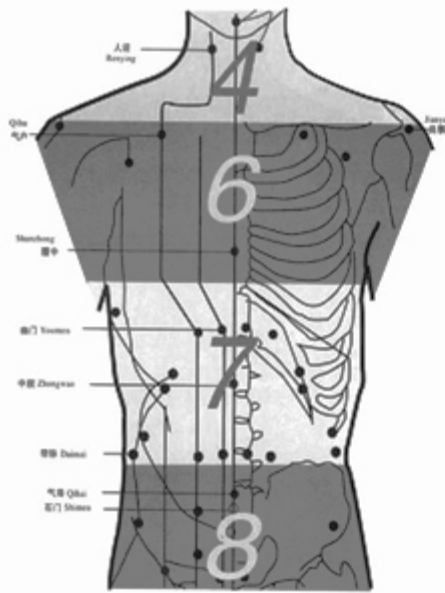

胸部、腹部穴区
Acupoint areas of chest and abdomen

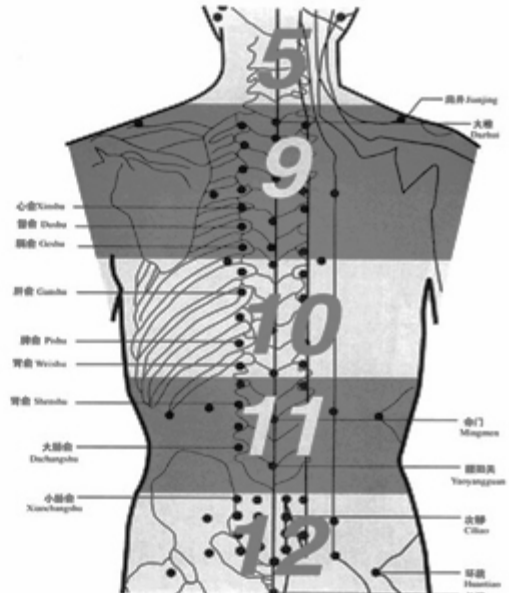

背部、腰部、臀部穴区
Acupoint areas of the back, loin and buttocks

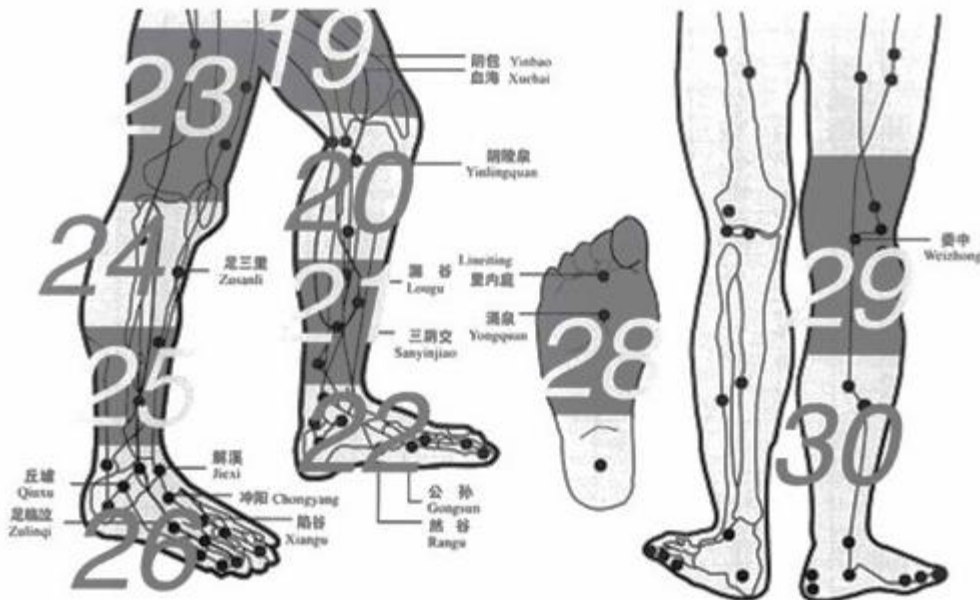

下肢穴区(1)
Acupoint areas of lower limbs(1)

下肢穴区(2)
Acupoint areas of lower limbs(2)

RHINITIS, NASOSINUSITIS, ACNE ROSACEA

E.N.T. Department and Stomatology Department

Treatment Mechanism of infrared therapy device / Bio-spectrum Treatment Device:

Irradiation on the nose and sinuses can improve the blood circulation of the nasal cavity, promote the

absorption of the inflammatory secretion, and reduce the abnormal activity of the nerve. Thoroughly clean the nasal cavity and close eyes when irradiating.

Acne Rosacea: adjust the emotions, regulate endocrine. Irradiate on the nose and back

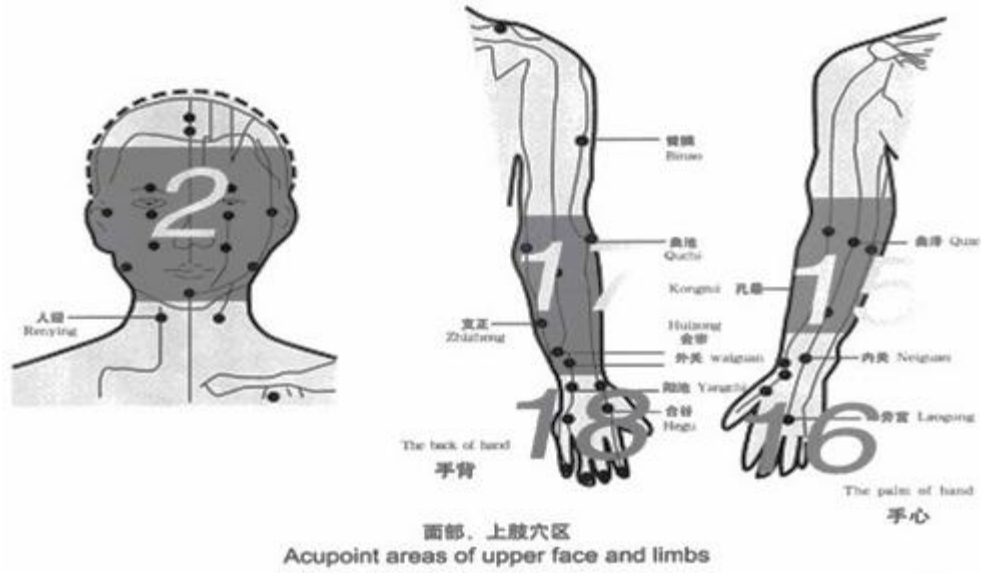

waist.

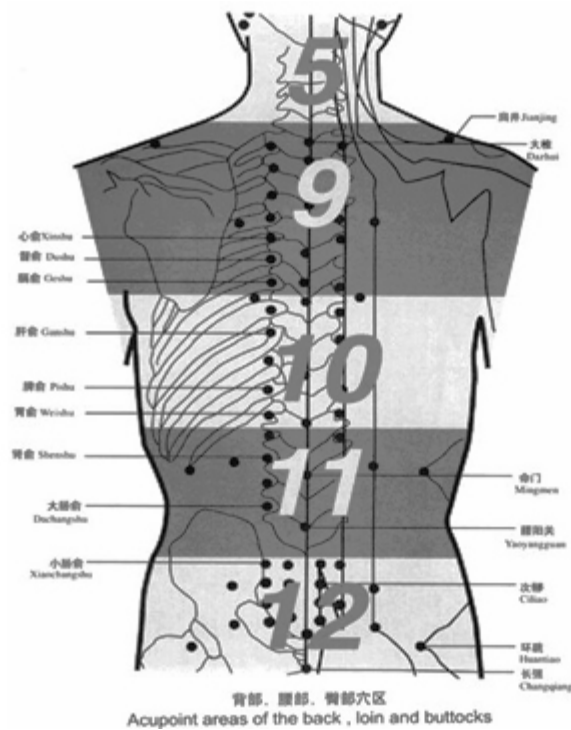

FAUCITIS

E.N.T. Department and Stomatology Department

Treatment Method: irradiate on the throat and use antibiotics

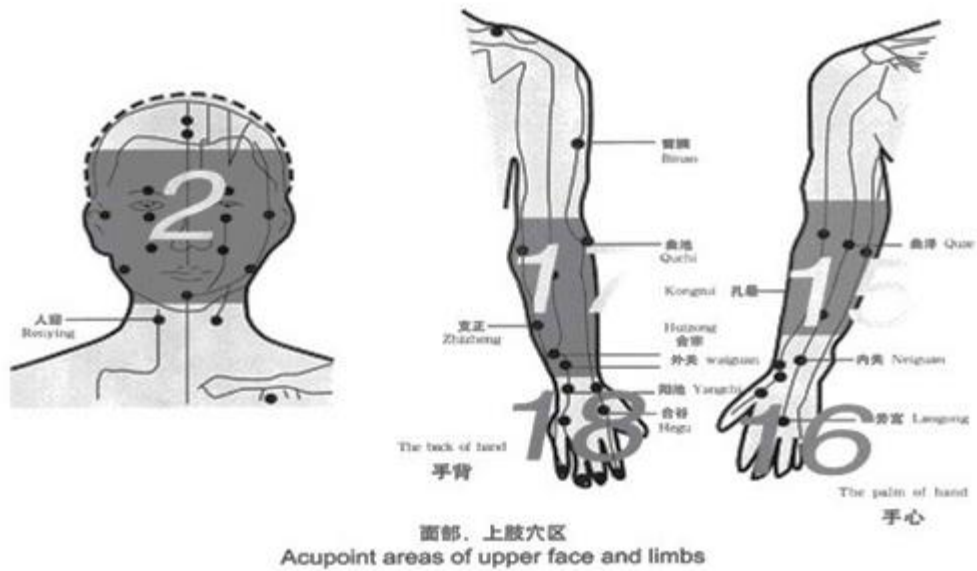

CHRONIC PROSTATITIS

Urinary and Genital System Diseases

Treatment Method:

Irradiated area: Acupoint area 8 and 12, Irradiated times and duration: twice daily, 30 min. each time

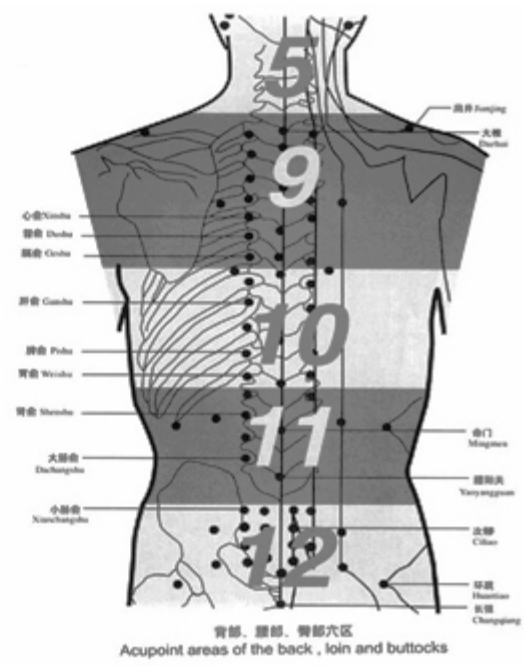
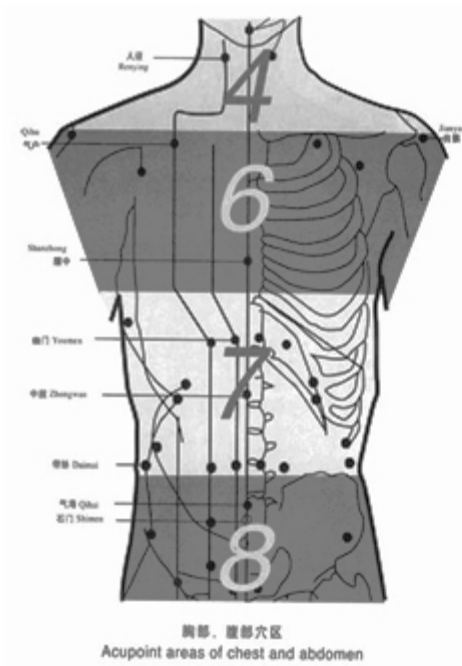

NEPHROPATHY, CYSTITIS, PROSTATITIS

Urinary and Genital System Diseases

Irradiated area: kidney (Nephropathy), lower abdomen (Cystitis), Perineum and the lower back Shenyu 11 Acupoint (Prostatitis)

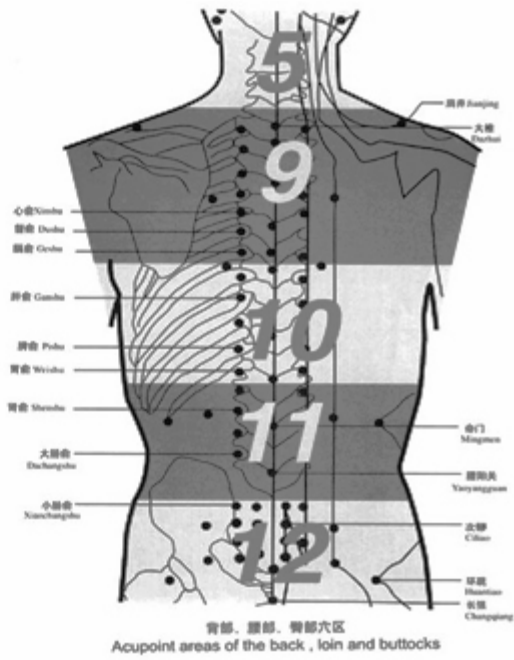
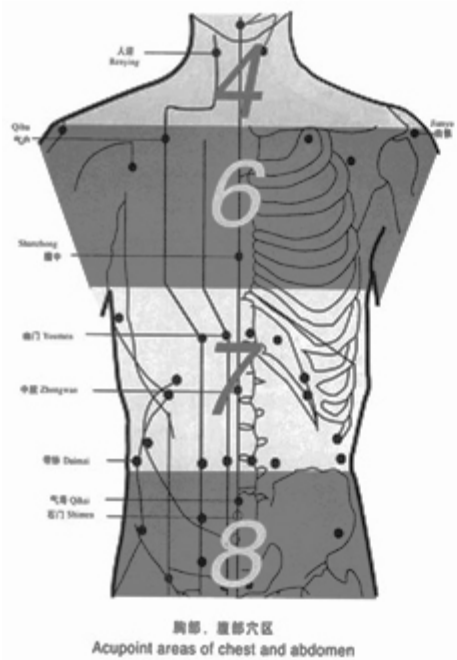

SOFT TISSUE INJURY

Musculoskeletal Department

Treatment Method: Irradiated area: affected area and Acupoint area 26

Irradiated times and duration: two times daily, 30 min. each time

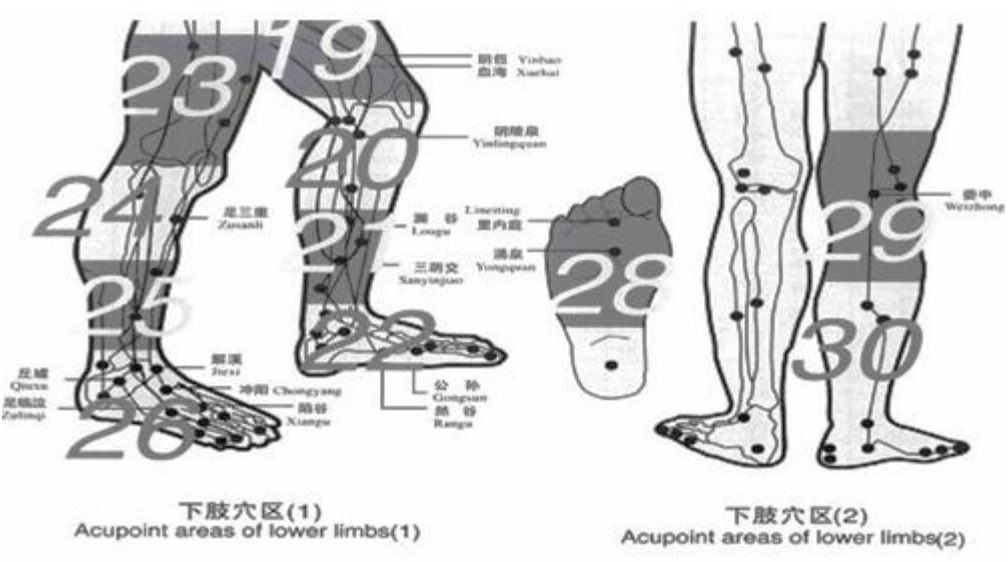

LUMBAR MUSCLE STRAIN, LUMBAGO AND LEG PAIN

Musculoskeletal Department

Treatment Method:

Irradiated area: affected area and Acupoint area 11, 29

Irradiated times and duration: two times daily, 30 min. each time

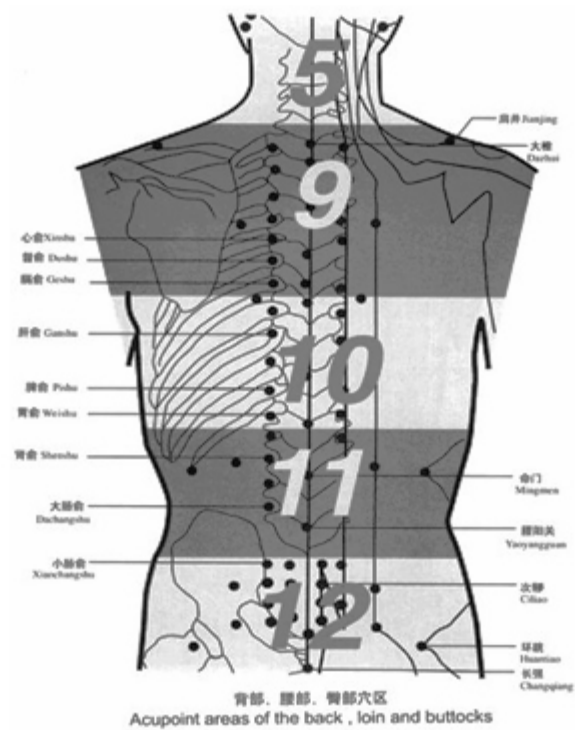

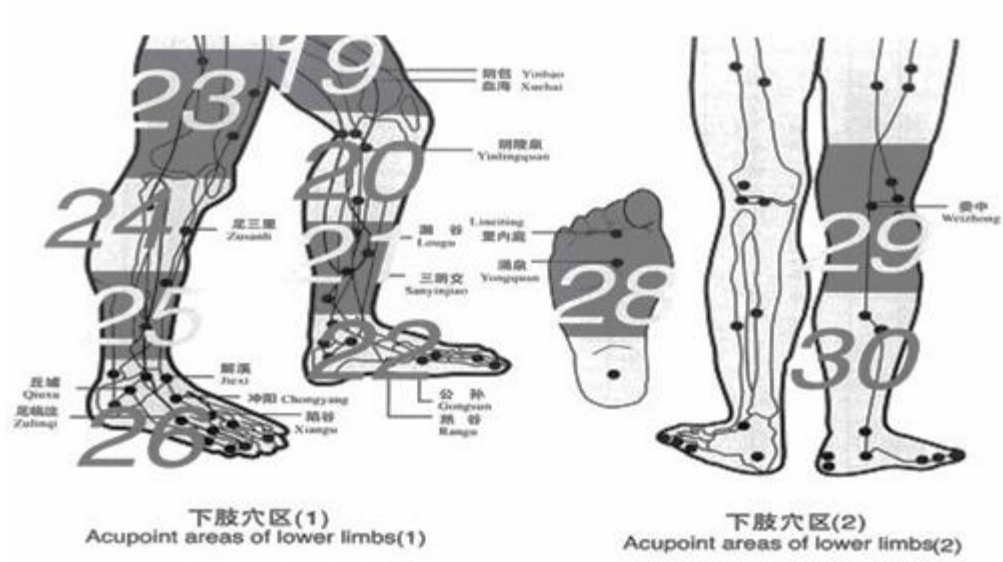

OSTEOARTHRITIS

Musculoskeletal Dpartment

Treatment Method:

Irradiated area: affected area

Irradiated times and duration: twice daily, 40 min. each time

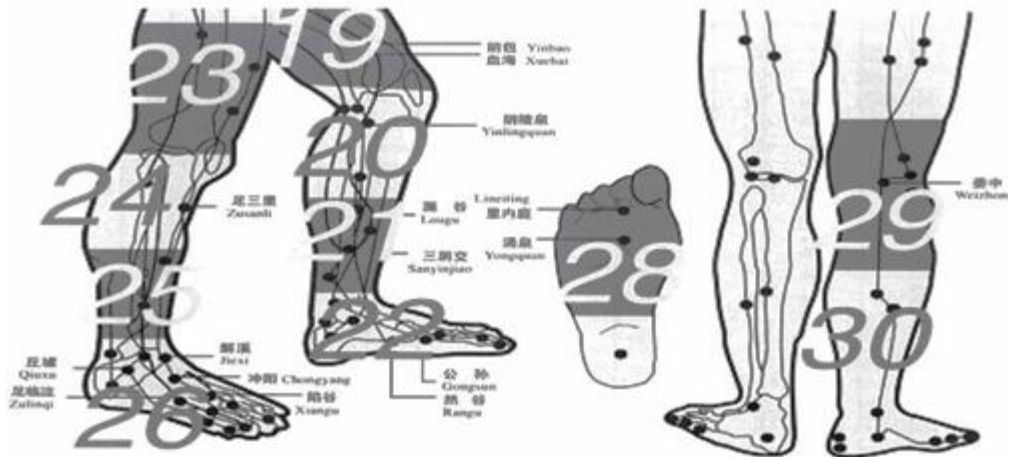

下肢穴区(1)
Acupoint areas of lower limbs(1)

下肢穴区(2)
Acupoint areas of lower limbs(2)

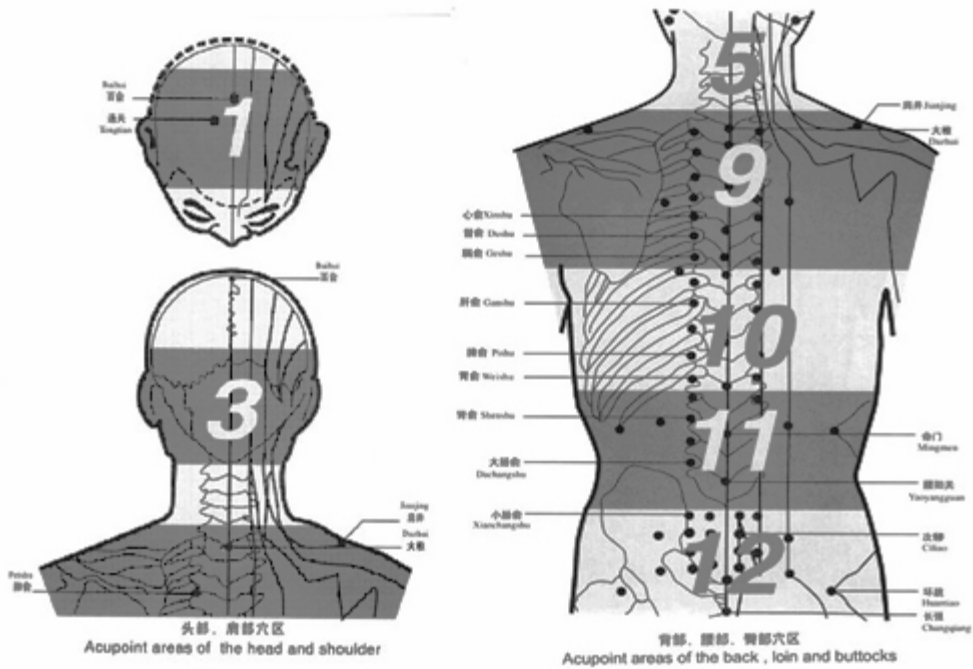

头部、颈部穴区
Acupoint areas of the head and shoulder

背部、腰部、臀部穴区
Acupoint areas of the back, loin and buttocks

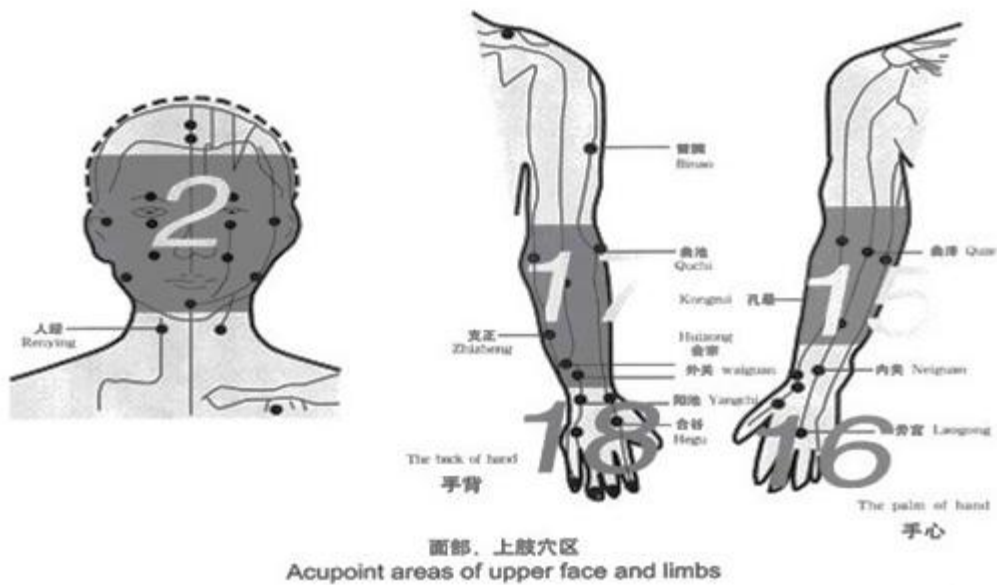

CERVICAL SPONDYLOSIS

Musculoskeletal Dpartment

Treatment Method:

Irradiated area: Acupoint area 9

Irradiated times and duration: two times daily, 30 min. each time

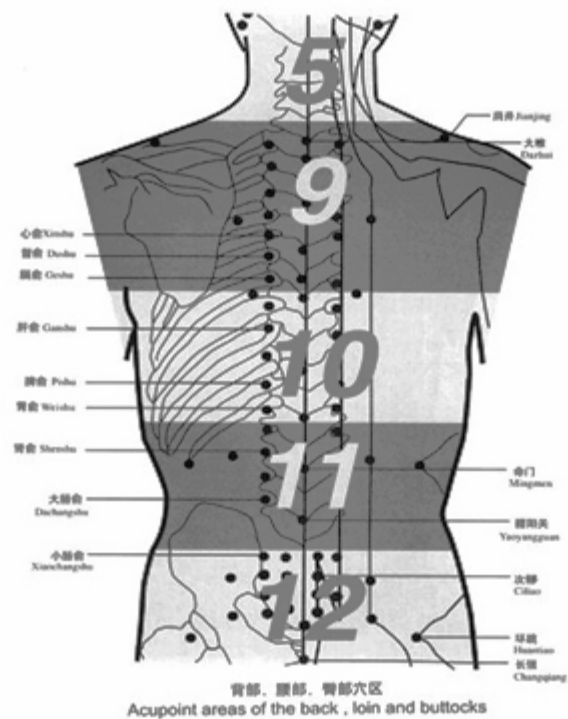

PERIARTHRITIS OF SHOULDER

Musculoskeletal Department

Treatment Method:

Irradiated area: affected area and Acupoint area 18

Irradiated times and duration: two times daily, 30 min. each time

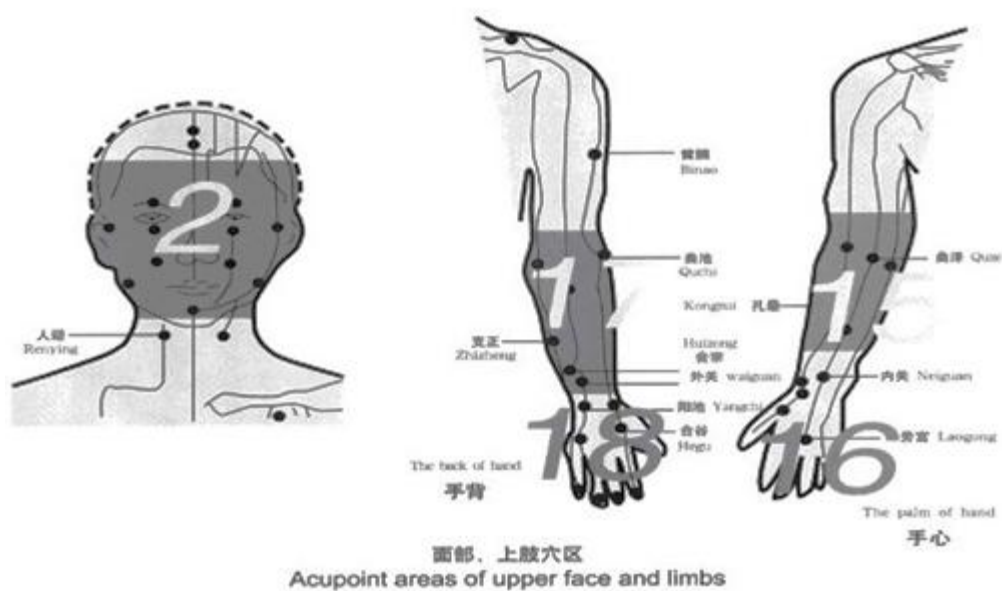

PELVIC INFLAMMATORY DISEASE, MENORRHALGIA, MENOXENIA

Pediatrics and Gynaecology Department - Urinary and Genital System Diseases

Treatment Method:

Irradiated area: Acupoint area 8, 19

Irradiated times and duration: 1-2 times daily, 30-40 min. each time

Note: Don't irradiate on the perineum 27 during monthly period

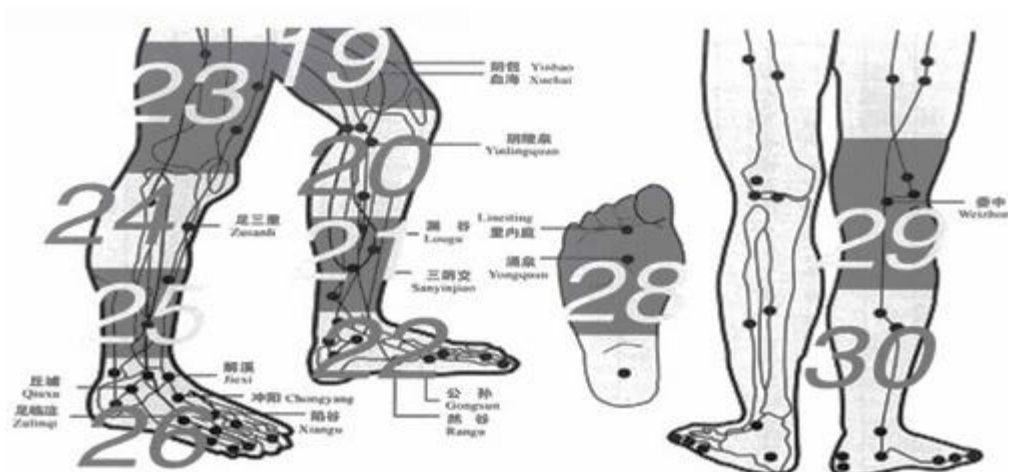
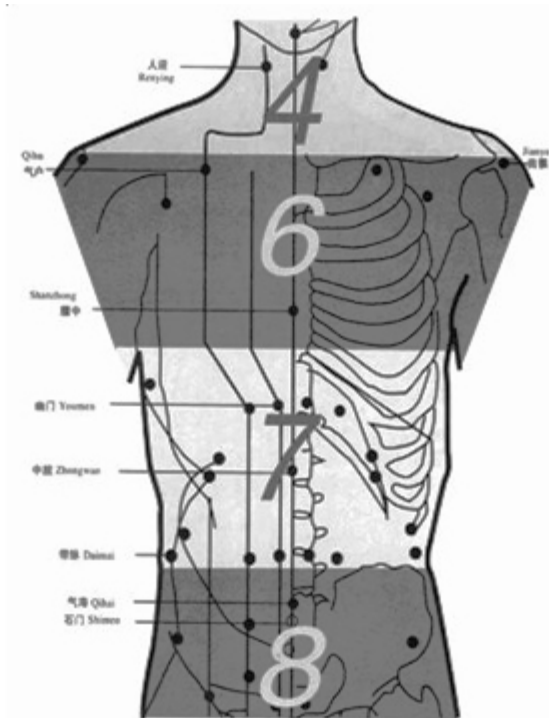

下肢穴区(1)
Acupoint areas of lower limbs(1)

下肢穴区(2)
Acupoint areas of lower limbs(2)

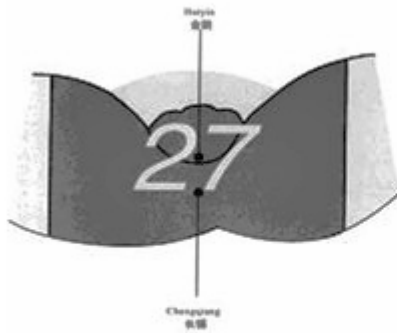

会阴穴区
Acupoint areas of peri-trunk

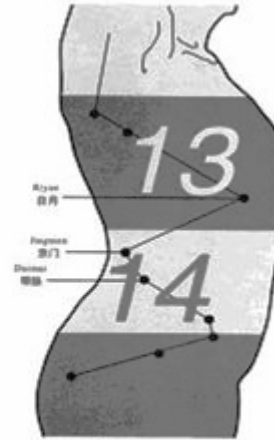

体侧穴区
Acupoint areas of perineum

CERVICITIS, ANNEXITIS, VAGINITIS

Pediatrics and Gynaecology Department - Urinary and Genital System Diseases

Treatment Method: Irradiated area: Acupoint area 8, 12, 27

Irradiated times and duration: 1-2 times daily, 30-40 min. each time

Note: Don't irradiate on the perineum during monthly period.

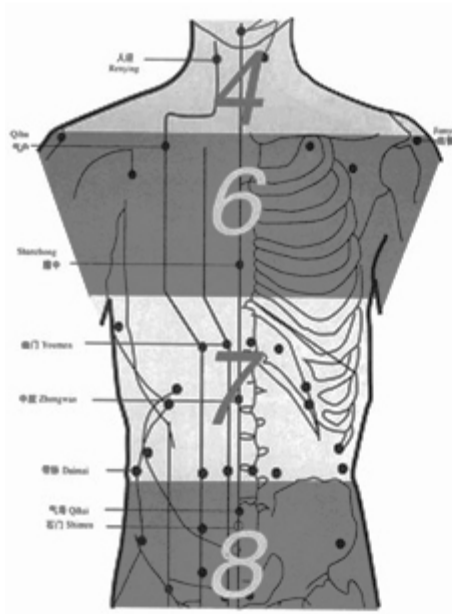

胸部、腹部穴区
Acupoint areas of chest and abdomen

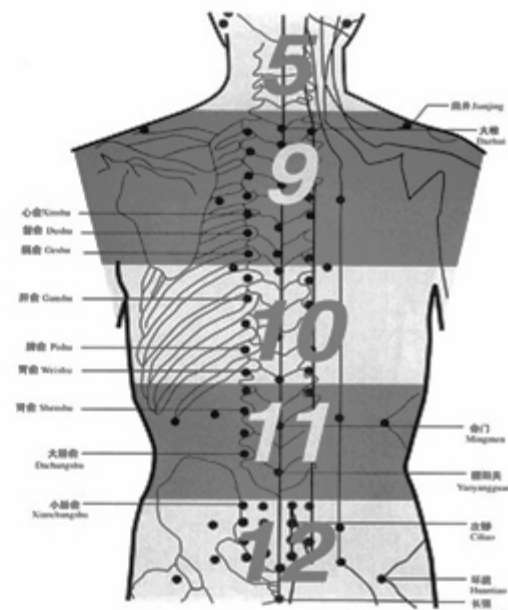

背部、腰部、臀部穴区
Acupoint areas of the back, loin and buttocks

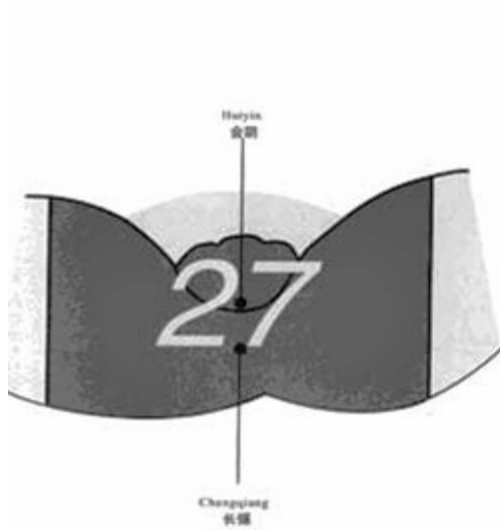

会阴穴区
Acupoint areas of peri-trunk

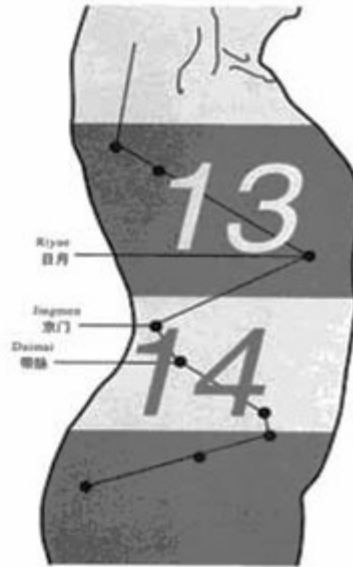

体侧穴区
Acupoint areas of perineum

INFANTILE PNEUMONIA

Pediatrics and Gynaecology Department - Respiratory Diseases

Treatment Method:

Irradiated area: affected area and Acupoint area 6, 9, 11

Irradiated times and duration: two times daily, 30 min. each time

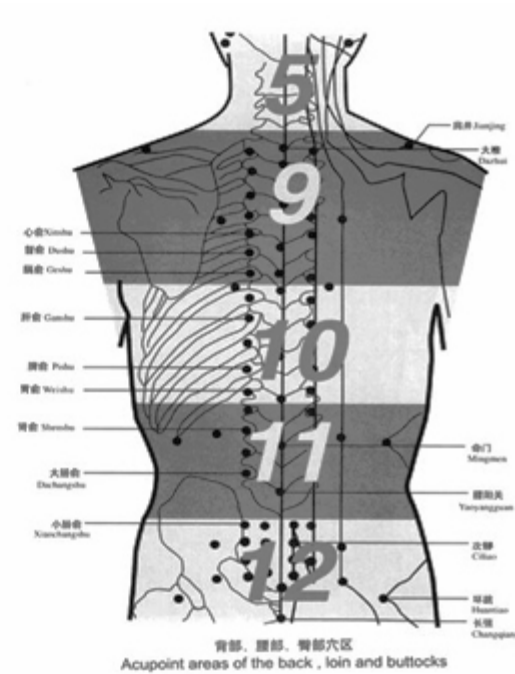
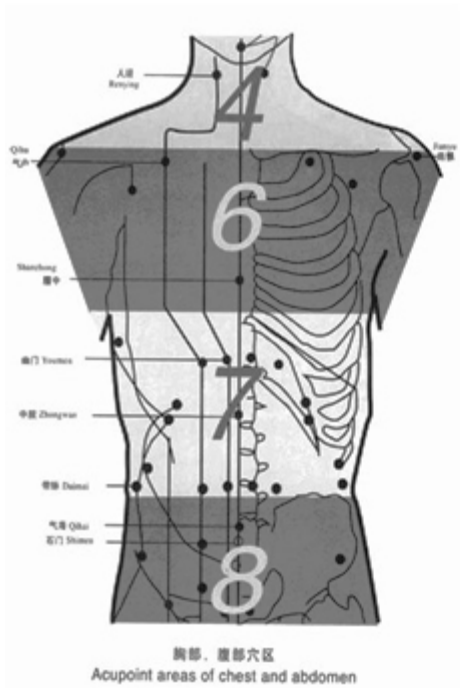

MUMPS

Pediatrics and Gynaecology Department - Respiratory Diseases

Treatment Method: Irradiated area: affected area

Irradiated times and duration: two times daily, 30 min. each time

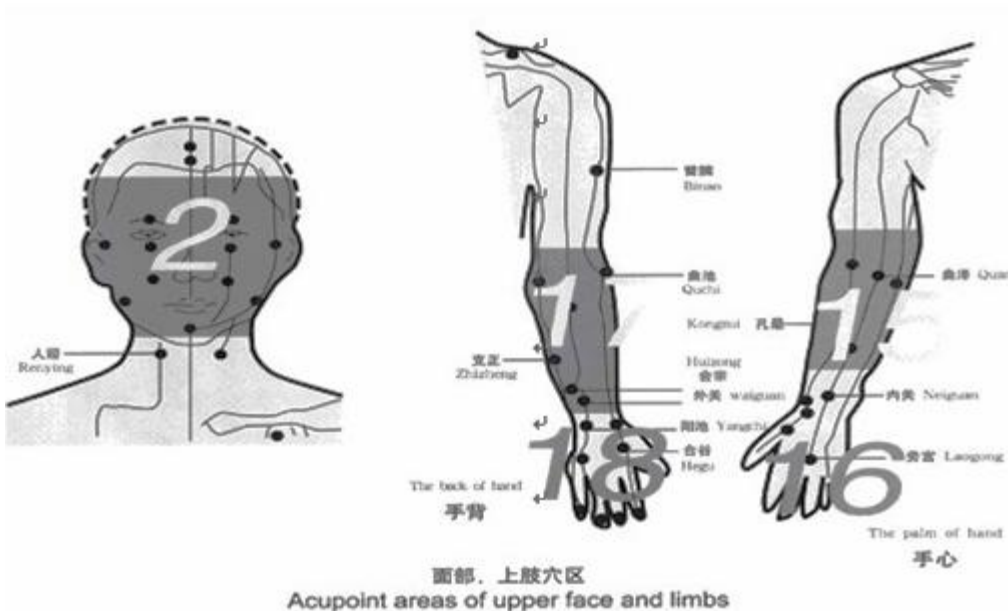

HEALTH CARE FOR AGED

disease prevention and anti-aging

Treatment Method: Irradiated area: Acupoint area 6, 28

Irradiated times and duration: once daily, 30 min. each time

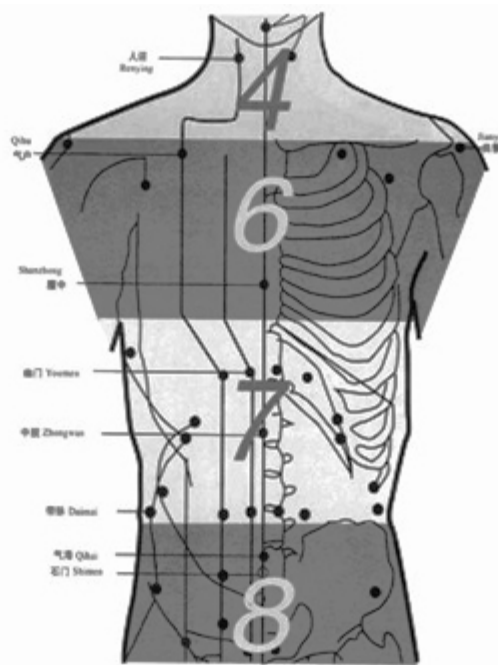

胸部、腹部穴区
Acupoint areas of chest and abdomen

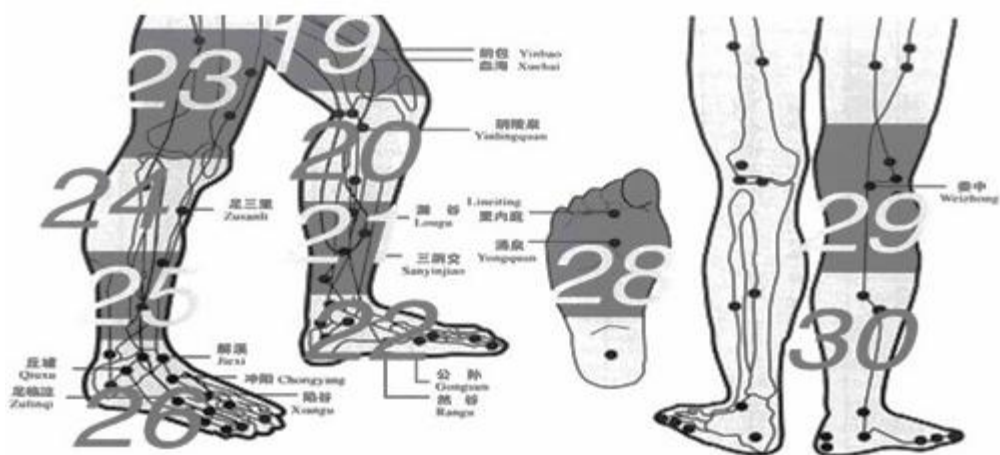

下肢穴区(1)
Acupoint areas of lower limbs(1)

下肢穴区(2)
Acupoint areas of lower limbs(2)

HEALTH CARE FOR YOUTH AND MIDDLE AGED

Reduce fatigue, promote energy, beauty care

Treatment Method: Irradiated area: Acupoint area 8 or 11, and 28 (Note: Acupoint area 8 for women, 11 for men)

Irradiated times and duration: once daily, 30 min. each time

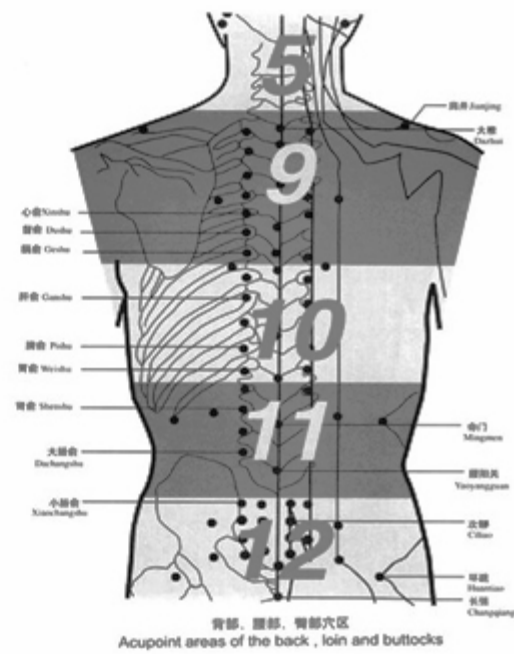
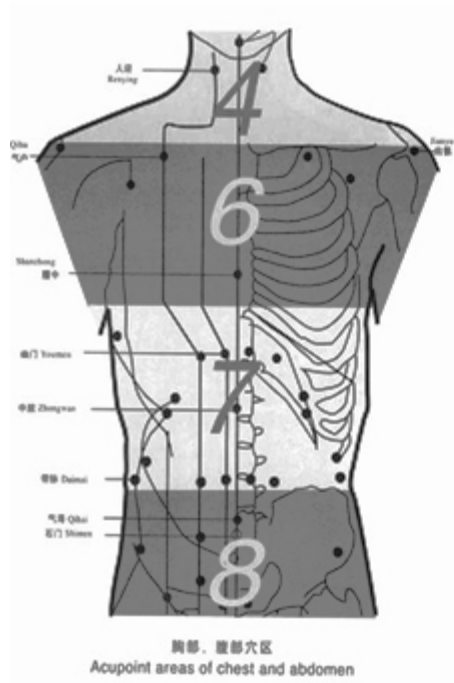

HEALTH CARE FOR CHILDREN

Increase nutrient absorption and digestion; enhance immunity

Treatment

Method:

Irradiated area: Neck, sides of neck and Acupoint area 7

Irradiated times and duration: one times daily, 15-20 min. each time (low power)

